

SOT-23 Plastic-Encapsulate Transistors

MMBT2222A TRANSISTOR (NPN)

FEATURES

- Epitaxial planar die construction
- Complementary PNP Type available(MMBT2907A)

MAXIMUM RATINGS (T_a=25°C unless otherwise noted)

Symbol	Parameter	Value	Unit
V _{CB0}	Collector-Base Voltage	75	V
V _{CEO}	Collector-Emitter Voltage	40	V
V _{EBO}	Emitter-Base Voltage	6	V
I _C	Collector Current	600	mA
P _C	Collector Power Dissipation	300	mW
R _{θJA}	Thermal Resistance From Junction To Ambient	417	°C/W
T _J	Junction Temperature	150	°C
T _{stg}	Storage Temperature	-55~+150	°C

SOT-23

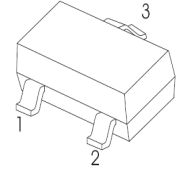

1. BASE
2. EMITTER
3. COLLECTOR

ELECTRICAL CHARACTERISTICS (T_a=25°C unless otherwise specified)

Parameter	Symbol	Test conditions	Min	Typ	Max	Unit
Collector-base breakdown voltage	V _{(BR)CBO}	I _C = 10μA, I _E =0	75			V
Collector-emitter breakdown voltage	V _{(BR)CEO} *	I _C = 10mA, I _B =0	40			V
Emitter-base breakdown voltage	V _{(BR)EBO}	I _E =10μA, I _C =0	6			V
Collector cut-off current	I _{CBO}	V _{CB} =60V, I _E =0			0.01	μA
Collector cut-off current	I _{CEX}	V _{CE} =30V, V _{BE(off)} =3V			0.01	μA
Emitter cut-off current	I _{EBO}	V _{EB} = 3V, I _C =0			0.1	μA
DC current gain	h _{FE(1)} *	V _{CE} =10V, I _C = 150mA	100		300	
	h _{FE(2)}	V _{CE} =10V, I _C = 0.1mA	40			
	h _{FE(3)} *	V _{CE} =10V, I _C = 500mA	42			
Collector-emitter saturation voltage	V _{CE(sat)} *	I _C =500 mA, I _B = 50mA I _C =150 mA, I _B =15mA			1 0.3	V
Base-emitter saturation voltage	V _{BE(sat)} *	I _C =500 mA, I _B = 50mA I _C =150 mA, I _B =15mA			2.0 1.2	V
Transition frequency	f _T	V _{CE} =20V, I _C = 20mA, f=100MHZ	300			MHz
Delay time	t _d	V _{CC} =30V, V _{BE(off)} =-0.5V			10	ns
Rise time	t _r	I _C =150mA, I _{B1} = 15mA			25	ns
Storage time	t _s	V _{CC} =30V, I _C =150mA			225	ns
Fall time	t _f	I _{B1} =-I _{B2} =15mA			60	ns

*pulse test: Pulse Width ≤300μs, Duty Cycles ≤ 2.0%.

CLASSIFICATION OF h_{FE}

RANK	L	H
RANGE	100 - 200	200 - 300
MARKING	1D	

Typical Characteristics

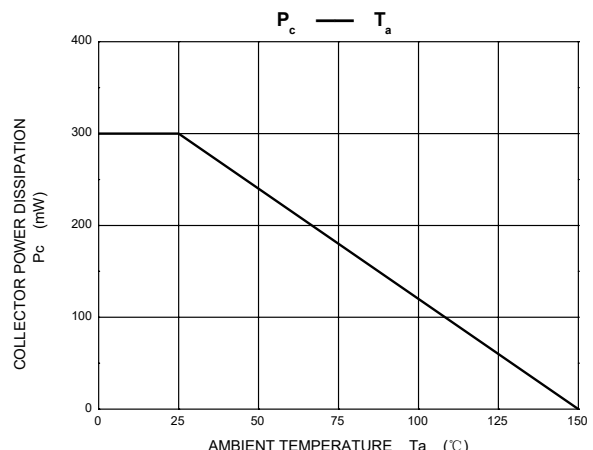
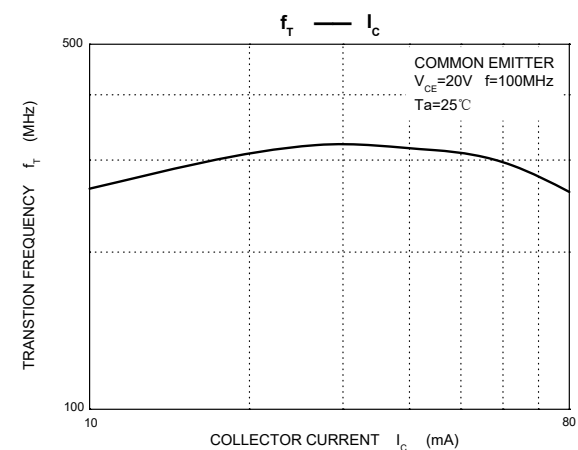
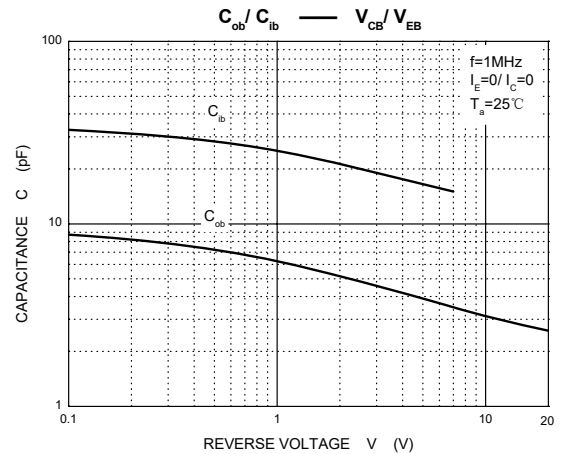
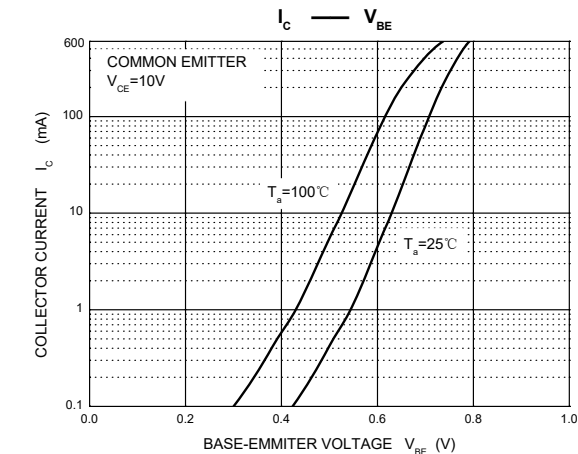
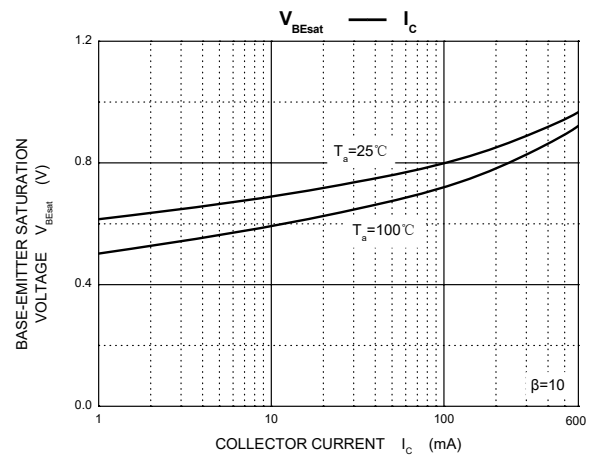
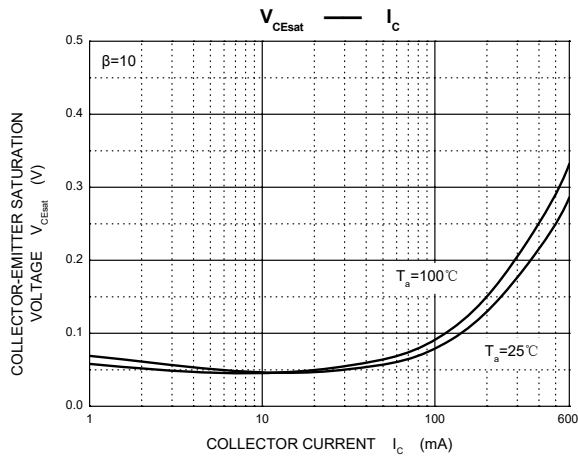
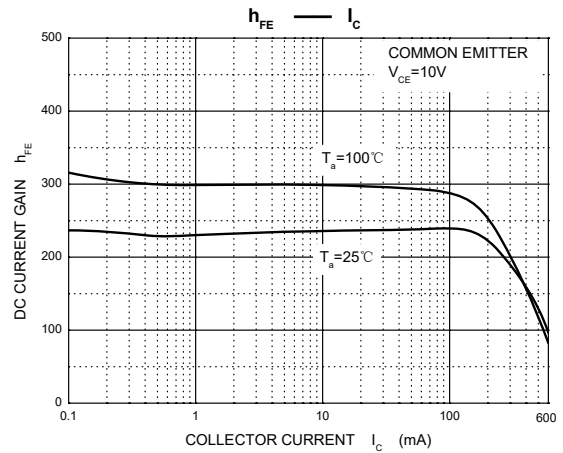
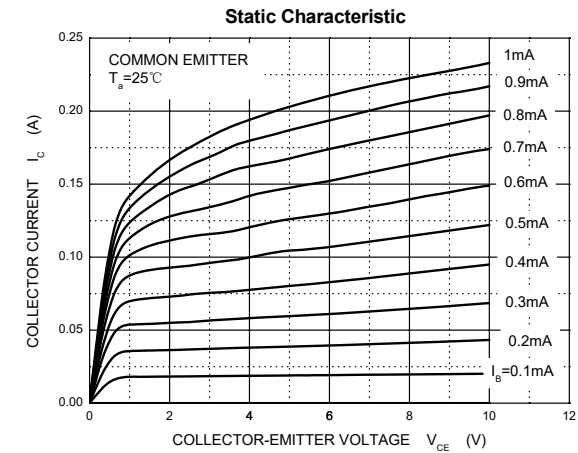

Outline Drawing

SOT-23 Package Outline Dimensions

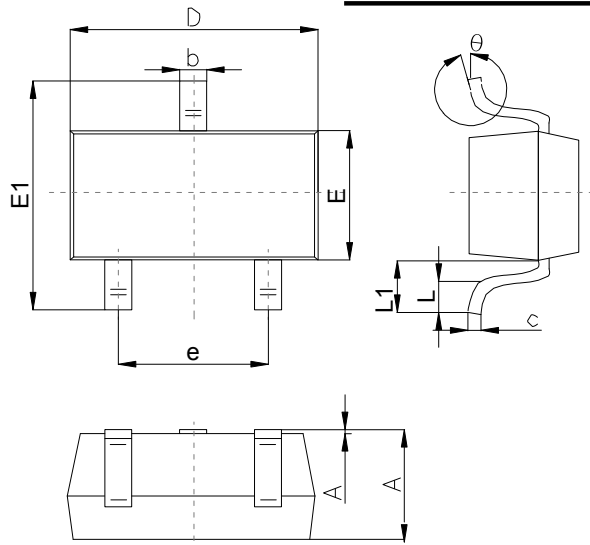

Symbol	Dimensions In Millimeters		
	Min	Typ	Max
A	0.90		1.40
A1	0.00		0.10
b	0.30		0.50
c	0.08		0.20
D	2.80	2.90	3.10
E	1.20		1.60
E1	2.25		2.80
e	1.80	1.90	2.00
L	0.10		0.50
L1	0.4		0.55
θ	0°		10°

Suggested Pad Layout

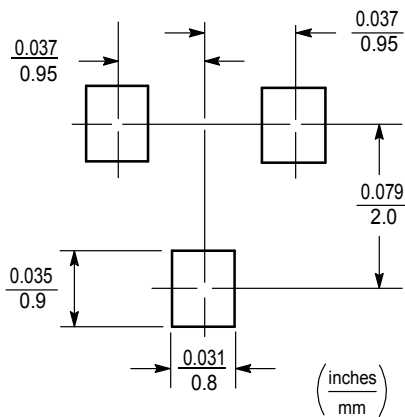

Note:

1. Controlling dimension:in/millimeters.
2. General tolerance: ± 0.05 mm.
3. The pad layout is for reference purposes only.

SOT-23 Tape and Reel

SOT-23 Embossed Carrier Tape

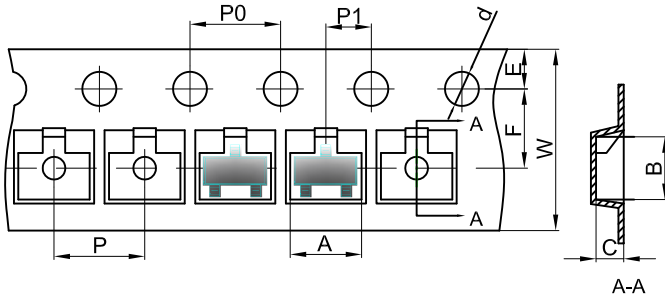
Packaging Description:

SOT-23 parts are shipped in tape. The carrier tape is made from a dissipative (carbon filled) polycarbonate resin. The cover tape is a multilayer film (Heat Activated Adhesive in nature) primarily composed of polyester film, adhesive layer, sealant, and anti-static sprayed agent. These reeled parts in standard option are shipped with 3,000 units per 7" or 17.8cm diameter reel. The reels are clear in color and is made of polystyrene plastic (anti-static coated).

Dimensions are in millimeter										
Pkg type	A	B	C	d	E	F	P0	P	P1	W
SOT-23	3.15	2.77	1.22	Ø1.50	1.75	3.50	4.00	4.00	2.00	8.00

SOT-23 Tape Leader and Trailer

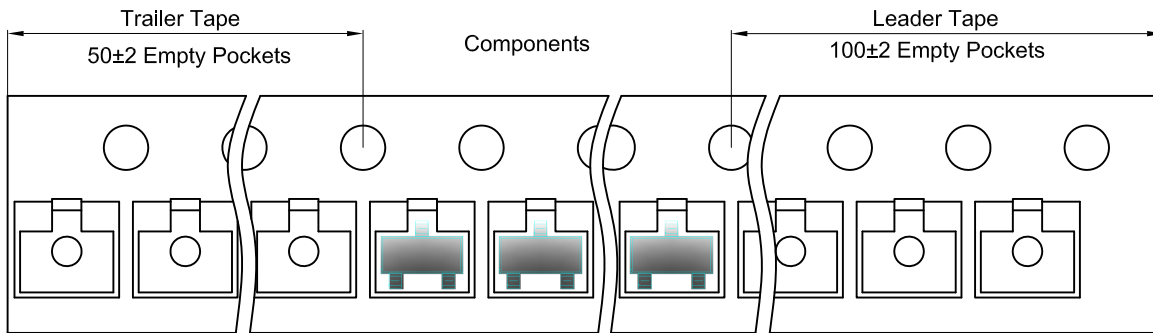

SOT-23 Reel

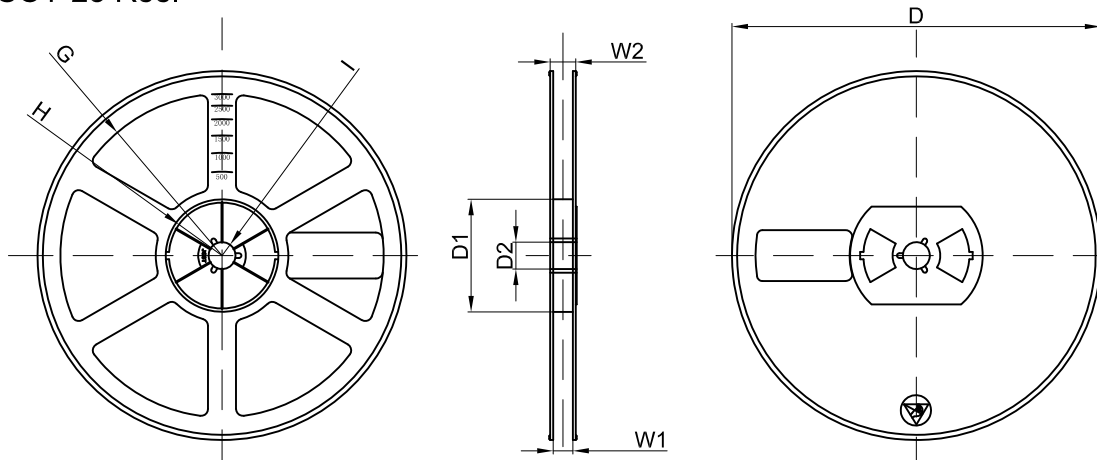

Dimensions are in millimeter								
Reel Option	D	D1	D2	G	H	I	W1	W2
7" Dia	Ø178.00	54.40	13.00	R78.00	R25.60	R6.50	9.50	12.30

REEL	Reel Size	Box	Box Size(mm)	Carton	Carton Size(mm)	G.W.(kg)
3000 pcs	7 Inch	45,000 pcs	203×203×195	180,000 pcs	438×438×220	