

2334236-6 ✓ ACTIVE



zQSFP+/QSFP28

TE Internal #: 2334236-6

QSFP28 to SFP+ Cable Assembly, 16 Positions, 9.84 ft [3 m], 25 Gb/s, Black Cable, Shielded, 30 AWG, .051 mm², Madison TurboTwin - Round Jacketed

[View on TE.com >](#)

Cable Assemblies > Copper Cable Assemblies > Pluggable I/O Cable Assemblies > QSFP28-Four SFP+ Cable Assembly: 30 AWG



Cable Assembly Type: QSFP28 to SFP+

Equalized: No

Wire Size: .051 mm²

Outside Cable Diameter: 4.37 mm [.172 in]

[All QSFP28-Four SFP+ Cable Assembly: 30 AWG \(6\)](#)

Features

Product Type Features

Cable Assembly Category	High Speed, Industry Standard
Cable Assembly Type	QSFP28 to SFP+
Connector Type (End A)	QSFP28 Plug
Connector Type (End B)	SFP+ Plug
Cable Style	Madison TurboTwin - Round Jacketed

Configuration Features

Number of Positions	16
Number of Pairs	8
Number of Signal Positions	16

Electrical Characteristics

Impedance	100 Ω
-----------	-------

Signal Characteristics

Data Rate	25 Gb/s
-----------	---------



Body Features

Equalized	No
Cable Color	Black
Cable Flammability Rating	CL2

Dimensions

Wire Size	.051 mm ²
Outside Cable Diameter	4.37 mm[.172 in]

Operation/Application

Shielded	Yes
Halogen Free	No

Other

Cable Assembly Length	3 m[9.84 ft]
-----------------------	--------------

Product Compliance

[For compliance documentation, visit the product page on TE.com>](#)

EU RoHS Directive 2011/65/EU	Compliant with Exemptions
EU ELV Directive 2000/53/EC	Not Compliant
China RoHS 2 Directive MIIT Order No 32, 2016	Restricted Materials Above Threshold
EU REACH Regulation (EC) No. 1907/2006	Current ECHA Candidate List: JUNE 2023 (235) Not Yet Reviewed
Halogen Content	Not Yet Reviewed for halogen content
Solder Process Capability	Not applicable for solder process capability

Product Compliance Disclaimer

This information is provided based on reasonable inquiry of our suppliers and represents our current actual knowledge based on the information they provided. This information is subject to change. The part numbers that TE has identified as EU RoHS compliant have a maximum concentration of 0.1% by weight in homogenous materials for lead, hexavalent chromium, mercury, PBB, PBDE, DBP, BBP, DEHP, DIBP, and 0.01% for cadmium, or qualify for an exemption to these limits as defined in the Annexes of Directive 2011/65/EU (RoHS2). Finished electrical and electronic equipment products will be CE marked as required by Directive 2011/65/EU. Components may not be CE marked. Additionally, the part numbers that TE has identified as EU ELV compliant have a maximum concentration of 0.1% by weight in homogenous materials for lead, hexavalent chromium, and mercury, and 0.01% for cadmium, or qualify for an exemption to these limits as defined in the Annexes of Directive 2000/53/EC (ELV). Regarding the REACH Regulations, TE's information on SVHC in articles for this part number is still based on the European Chemical Agency (ECHA) 'Guidance on requirements for substances in articles' (Version: 2, April 2011), applying the 0.1% weight on weight concentration threshold at the finished product level. TE is aware of the European Court of Justice ruling of September 10th, 2015 also known as O5A (Once An Article Always An Article) stating that, in case of 'complex object', the threshold for a SVHC must be applied to both the product as a whole and simultaneously to each of the articles forming part of its composition. TE has evaluated this ruling based on the new ECHA "Guidance on requirements for substances in articles" (June 2017, version 4.0) and will be updating its statements accordingly.

Compatible Parts



TE Part # CAT-Z8-P6507
zSFP+ Stacked Cage Assembly: Gasket



TE Part # CAT-SF59-C117ST123
SFP+ Stacked Cage Assemblies



TE Part # CAT-Z8-P650632
zSFP+ Cage Assembly: EMI Springs



TE Part # CAT-Z8-P650796
zSFP+ Stacked Cage Assembly: EMI Spring



TE Part # 2170705-7
CAGE ASSY, QSFP28 1X1, SPRING, HS, LP



TE Part # 2007250-1
SFP+ 1x6 Cage Assembly with Light Pipes



TE Part # 2170747-6
CAGE ASSY, 1X4, QSFP28, SPRING, HS, LP



TE Part # 2170806-5
CAGE ASSEMBLY, 1X2, QSFP28, SPRING, HS



TE Part # 2-2170747-2
CAGE ASSY, 1X4, QSFP28, SPRING, HS, LP



TE Part # 2007135-1
SFP+ 1x4 CageAssembly w/ EMI gasket



TE Part # 2170704-2
CAGE ASSY, QSFP28 1X1, SPRING, HS



TE Part # 2227103-2
1X2 CAGE ASSY BHND BZL QSFP28



TE Part # 2170707-3
CAGE ASSY, 1X6, QSFP28, SPRING, HS



TE Part # 2007180-1
SFP+ 1X2 CAGE ASSM/LIGHTPIPE, EMI GASKET



TE Part # 2227103-1
1X2 CAGE ASSY BHND BZL QSFP28



TE Part # 2007254-1
SFP+ 1x1 Cage Assembly, Light Pipe



TE Part # 2198230-2
SFP+ Enhanced 1x2, SAN Heatsink



TE Part # 2198230-1
SFP+ Enhanced 1x2, PCI Heatsink



TE Part # 2170704-1
CAGE ASSY, QSFP28 1X1, SPRING, HS



TE Part # 2170704-5
CAGE ASSY, QSFP28 1X1, SPRING, HS

Also in the Series | zQSFP+/QSFP28

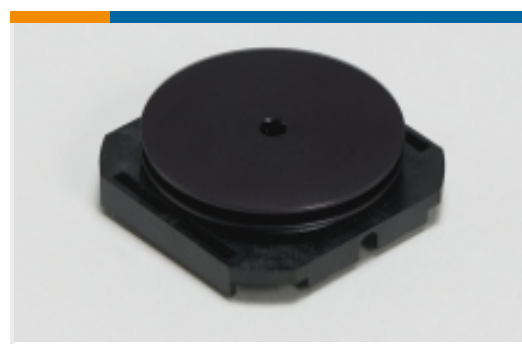

Heat Sinks(1)



Pluggable I/O Cable Assemblies(81)

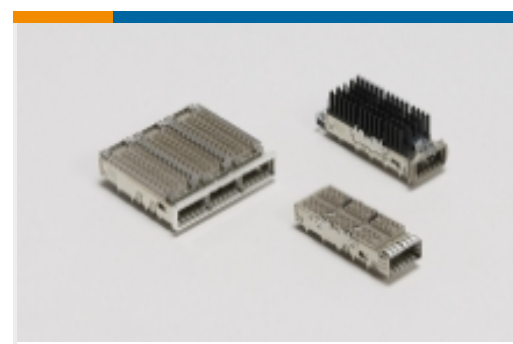

QSFP, QSFP+ & zQSFP+(425)

Customers Also Bought

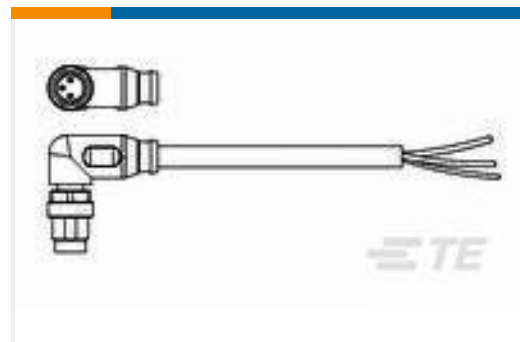
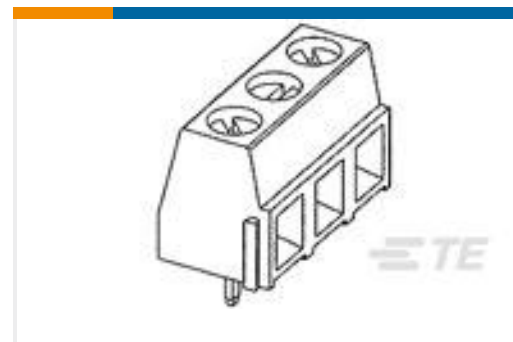
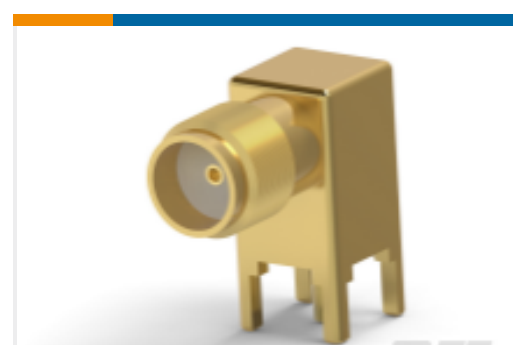
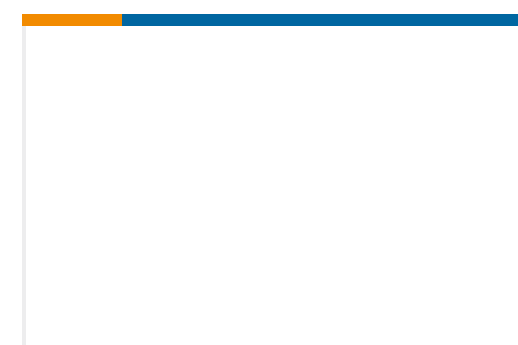
TE Part #1462051-2
HF353=50OHM140MW 5V MONOTE Part #2273008-1
M8 x 1.0 Angled plug PigtailTE Part #282836-2
TERMI-BLOK PCB MOUNT 90 2P.TE Part #2267080-1
TMS6T1B1M1QETE Part #T4070014031-001
M8.MLE.PNLREAR.3POS.STR WIRETE Part #665143-000
S01-01-RTE Part #5-1814400-2
SMA R/A PCB Skt GZDTE Part #9-1462038-9
IM03DGR=IM RELAY 140mW 5V

Documents

Product Drawings

[QSFP TO \[4\]SFP25GIG 30AWG 3 METER](#)

English

CAD Files

[3D PDF](#)

3D

Customer View Model

[ENG_CVM_CVM_2334236-6_A.2d_dxf.zip](#)

English

Customer View Model

[ENG_CVM_CVM_2334236-6_A.3d_igs.zip](#)

English

Customer View Model

[ENG_CVM_CVM_2334236-6_A.3d_stp.zip](#)

English

By downloading the CAD file I accept and agree to the [Terms and Conditions](#) of use.



Product Specifications

Product Specification

English

Product Specification

English