



承認書

APPROVE SHEET

客户名称 CUSTOMER : _____	
贵司制品名 CUSTOMER PN: _____	本公司制品名 PRODUCT PN: TACT SWITCH
贵司规格 APPROVAL DAT: _____	本公司规格 PRODUCT CODE: T3035824E10
客户料号 CUSTOMER NO: _____	本公司规格书编号 PRODUCT DRAWING NO: 2016022502

	批准 APPROVAL	审核 CHECK	设计 DESIGN			
<input type="radio"/> 新品承认 NEW APPROVE	 批准 李先缘	 审核 周颖鑫	 设计 颜明玉			
<input type="radio"/> 规格书变更承认 CHANGE CODE APPROVE AGAIN				DATE:	DATE:	DATE:
<input type="radio"/> 材料变更承认 CHANGE MATERIAL APPROVE AGAIN						

贵公司承认栏 APPROVAL SIGNATURE

印章

请于____年____月____日前承认返回我司 日期 DATE : _____

PLEASE RETURN TO US AFTER CONFIRMED! THANK YOU!

深圳市三佐部品电子有限公司

Shenzhen City Samzo Parts Electronics Co., Ltd.

电话 : 0769-82625505 电话 : 0769-82625503

邮箱 : samzohk@163.com 网址 : www.szo.hk

地址 : 东莞市塘厦镇东兴大道南56号振兴大厦806-809

世界零部件制造商

--SAMZO--



ISO9001 ISO14001

认证企业

规格承认书			规格书编号 2016022501
品名	TACT SWITCH 3.7*3.7*0.35	型号	T3035824E10
			1/7

1. General Specification 基本说明

1.1 Scope 范围 This specification covers the requirements for single key switches which have no key top(TACT SWITCHES:MECHANICAL CONTACT).此规范含盖单推柄和无推柄的轻触开关要求

1.2 Operating Temperature Range 使用温度范围
-30 ~85℃(normal humidity, normal press.) 正常湿度, 标准压力

1.3 Storage Temperature Range 保存温度范围
-40 ~90℃(normal humidity, normal press.)

1.4 Test Conditions 测试条件

Tests and measurements shall be made in the following standard conditions unless otherwise specified: 测试和计量按下列标准条件除非特殊说明

Normal temperature (temperature 5 ~35℃) 标准温度

Normal humidity (relative humidity 25 ~85%) 正常湿气

Normal pressure (pressure 86 ~106 Kpa) 标准压力

In case any question arises from the judgment made, tests shall be conducted in the following conditions:

Temperature (20±2℃) 温度

Relative humidity (60 ~70%) 相对湿度

Pressure (86 ~106Kpa) 压力

2. Type Of Actuation 动作类型

 Tactile feedback 轻触返回

3. Contact Arrangement 1 poles 2 throws 接触形式 1 回路 2 接点

(Details of contact arrangement are given in the assembly drawings.)
细接点形式在装配图中

4. Maximum Ratings DC 12 V 50 mA 最大额定值

DC 1 V 10 μ A 最小额定值

规格承认书

规格书编号
2016022501

品名

TACT SWITCH 3.7*3.7*0.35

型号

T3035824E10

2/7

6. General Specification 电气性能

Item 项目	Test Condition 测试条件	Requirements 要求
6.1. Contact Resistance 接触电阻	<p>Applying a below static load to the center of the stem measurements shall be made 中央按钮的测量需满足如下条件:</p> <p>(1) Depression 按压力: 4.4N (2) Measuring method: 1KHz small-current contact resistance meter or voltage drop method at 5VDC 10mA 测量方法: 1 KHZ 小电流接触电阻仪测量或者 5VDC 10mA 电压降下法</p>	500mΩ 以下
6.2. Insulation Resistance 绝缘电阻	<p>Measurements shall be made following application of DC100V potential between terminals and between individual terminals and frame for one minute. 在端子与端子之间, 端子与外壳之间施加 DC100V, 一分钟</p>	100MΩ 以上
6.3. Dielectric Withstanding Voltage 电气耐压	<p>AC100V(50Hz or 60Hz) shall be applied between terminals and between individual terminals and frame for one minute. 在端子与端子之间, 端子与外壳之间施加 AC100V(50HZ-60HZ) 一分钟</p>	There shall be no breakdown. 无击穿、闪烁现象
6.4. Bounce 抖动	<p>Lightly striking the center of the stem at a rate encountered in normal use (3 to 4 operations per sec), Bounce shall be tested when "ON" and "OFF". 在正常使用中(以每秒 3-4 回)轻轻地在手柄中心加力, 在通与断瞬间测试抖动</p> <div style="text-align: center;"> <p>t 为触点抖动时间</p> </div>	<p>First, Second action: ON bounce: <u>10</u>ms Max OFF bounce: <u>10</u> ms Max</p>

规格承认书

规格书编号
2016022501

品名

TACT SWITCH 3.7*3.7*0.35

型号

T3035824E10

3/7

7.Mechanical specification 机械的性能

Item 项目	Test Condition 测试条件	Requirements 要求
7.1	<p>Operating Force 动作力</p> <p>Placing the switch such that the direction of switch operation is vertical and then gradually increase the load applied to the top center of the stem.the maximum load required for the switch to come to a stop shall be measured . 开关的动作方向为垂直放置开关向推柄中心逐渐地增加负荷到推柄停止时所测量的最大负荷。</p>	<u>2.5 ± 0.5</u> N
7.2	<p>Travel 行程</p> <p>Placing the switch such that the direction of switch operation is vertical and then applying a below static load to the top center of the stem.the travel distance for the switch to come to a stop shall be measured. 开关的动作方向为垂直放置开关并以双倍动作力的静负荷作用推柄中心，测量推柄中心从开始到停止的行程距离。</p>	<u>0.16 ± 0.10</u> mm
7.3	<p>Return Force 返回力</p> <p>The sample switch is installed such that the direction of switch operation is vertical and, upon depression of the stem in its center the whole travel distance , the force of the stem to return to its free position shall be measured.开关的动作方向为垂直放置开关, 在已有行程的推柄中心向上减少压力，推柄回到自由位置时所测量到的力.</p>	<u>0.1N</u> min
7.4	<p>Static Strength 静止强度</p> <p>Placing the switch such that the direction of switch operation is vertical and then a below static load shall be applied in the dirction of stem operation. 开关的动作方向为垂直放置开关,开关操作方向施加以下静核重量 (1)Depression 按压力 : 30N (2) Direction: 时间 : 15 s (3)Number of times 回数 : 1 time</p>	<p>There shall be no sign of damage mechanically and electrically. 无机械的和电气的损伤迹象</p>

规格承认书

规格书编号
2016022501

品名	TACT SWITCH 3.7*3.7*0.35	型号	T3035824E10	4/7
----	--------------------------	----	-------------	-----

8. Environmental specification 使用耐侯性能

Item 项目	Test Condition 测试条件	Requirements 要求
8.1	<p>Moisture Resistance 耐潮湿</p> <p>Following the test set forth below the sample shall be left in normal temperature and humidity conditions for one hour before measurements are made: 样品按下列条件进行耐潮湿试验, 试验后在正常温度和湿度条件下放置 1 小时后测定</p> <p>(1) Temperature: 60±2°C 温度 (2) Relative humidity: 90 to 95% 相对湿度 (3) Time: 96 hours 时间</p> <p>Water drops shall be removed. 擦除水珠</p>	<p>Contact resistance: <u>500</u> mΩ Max. 接触电阻 (Item 6.1)</p> <p>Insulation resistance : <u>10</u> MΩ Min. 绝缘电阻 (Item 6.2)</p> <p>Item 6.3、6.4 Item 7.1、7.2</p>
8.2	<p>Low Temperature Resistance 耐低温</p> <p>Following the test set forth below the sample shall be left in normal temperature and humidity conditions for one hour before measurements are made: 样品按下列条件进行耐低温试验, 试验后在正常温度和湿度条件下放置 1 小时后测定</p> <p>(1) Temperature: -40±2°C 温度 (2) Time: 96 hours 时间</p> <p>Water drops shall be removed. 擦除水珠</p>	<p>Item 6. Item 7.1、 Item 7.2</p>
8.3	<p>Heat Resistance 耐热</p> <p>Following the test set forth below the sample shall be left in normal temperature and humidity conditions for one hour before measurements are made: 样品按下列条件进行耐热试验, 试验后在正常温度和湿度条件下放置 1 小时后测定</p> <p>(1) Temperature: 90±2°C 温度 (2) Time: 96 hours 时间</p>	<p>Item 6. Item 7.1 Item 7.2</p>
8.4	<p>Change of Temperature 温度循环</p> <p>Following ten cycles of high temperature test .The Sample shall be Placed in Normal temperature and humidity Conditions for one hour before measurements are made. During this test, water drops shall be removed. 样品按下列条件进行高低温循环试验, 试验后在正常温度和湿度条件下放置 1 小时后测定</p> <div style="display: flex; align-items: center;"> <div style="flex: 1;"> <p style="font-size: small;">温度(°C) ↑</p> <p style="font-size: small;">0°C</p> <p style="font-size: small;">A: +60°C B: -10°C C: 2 小时 D: 1 小时 E: 2 小时 F: 1 小时</p> <p style="font-size: small;">时间(hour) →</p> </div> <div style="flex: 1; margin-left: 20px;"> <p>(1) Number of cycles 周期: 5 cycles</p> </div> </div>	<p>Item 6. Item 7.1 Item 7.2</p>

规格承认书

规格书编号
2016022501

品名

TACT SWITCH 3.7*3.7*0.35

型号

T3035824E10

5/7

9. Environmental specification 使用耐久性能

Item 项目	Test Condition 测试条件	Requirements 要求
9.1 Operating Life 动作寿命	Measurements shall be made following the test set forth below: 按下列条件进行寿命试验 (1)DC 5V 5mA resistive load. DC 5V 5mA 阻性负载 (2)Rate of operation:2 to 3 operations per second 动作频率:2-3 次/每秒 (3)Depression: <u>5N</u> 减压力 (4)Cycles of operation: 100,000 cycles 动作次数: 100,000	Contact resistance: <u>1</u> Ω Max. 接触电阻 (Item6.1) Insulation resistance : <u>10</u> M Ω Min. 绝缘电阻 (Item6.2) Bounce (Item6.4) ON bounce: <u>20ms</u> Max OFF bounce: <u>20ms</u> Max Operating force: 动作力 (Item7.1) -30 %o+ <u>30%</u> of initial force. -30%~+30%初始动作力 (Item7.1) Item 6.3 Item 7.2
9.2 Vibration Resistance 耐振动	Measurements shall be made following the test set forth below: 按下列条件进行抗振动试验 (1)Range of oscillation: 10 to 55Hz 频率范围 (2)Amplitude,pk-to-pk:1.5mm 振幅:峰-峰 1.5mm (3)Cycle of sweep: 10-55-10Hz in one minute, approx.扫描周期: 10-55-10Hz 约一分钟内 (4)Mode of sweep: Logarithmically sweep or uniform sweep. 扫描方式: 对数扫描式恒定扫描 (5)Direction of oscillation: 振动方向 Three mutually perpendicular directions, including the direction of stem travel. 3个相互垂直方向,包括推柄行程方向 (6)2 hours each ,for a total of 6 hours.每方向 2 小时.共 6 小时	Item 6. Item 7.1 Item7.2
9.3 Impact Shock Resistance 抗冲击	Measurements shall be made following the test set forth below: 按下列条件进行冲击试验 (1) Acceleration: 784m/s ² 加速度 (2)Cycles of test : 3 cycles each in 6directions, for a total of 18cycles 试验次数: 每个方向 3 次, 6 个方向共 18 次	Item 6. Item 7.1 Item7.2

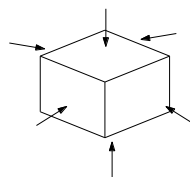

规格承认书

规格书编号
2016022501

品名

TACT SWITCH 3.7*3.7*0.35

型号

T3035824E10

6/7

10. Soldering conditions 焊接条件:

Item 项目		Recommended conditions 推荐条件
10.1	Hand Soldering 手工焊接	<p>Please practice according to bellow conditions: (1)Soldering temperature : 350°C Max (2)Continuous soldering time: 3 S Max (3)Capacity of soldering iron: 20 W Max 请按以下条件进行焊接: (1)焊锡温度: 350°C Max (2)连续焊接时间: 3 S Max (3)电烙铁的功率: 20 W Max</p>
10.2	Automatic Flow Soldering 自动焊接	<p>(1)For the product of SMT ,type solder according to the following conditions 对于 SMT 产品, 请按以下条件进行焊接</p> <div style="text-align: center;"> </div> <p>(1) Thickness of printed circuit board shall be 0.6mm. 印刷电路板的厚度 0.6 毫米</p> <p>(2) Time: 回数: 2 times max 2 回以内 Twice soldering would be reflow the temperature goes down to a normal temperature 两次回流焊接温度降到正常温度</p>

规格承认书				规格书编号 2016022501
品名	TACT SWITCH 3.7*3.7*0.35	型号	T3035824E10	7/7

11. Other Precautions 其他注意事项:

- (1) Following the soldering process, do not try to clean the switch with a solvent or the like.
进行焊接过程中，不可以用溶剂或类似品清洗开关
- (2) Safeguard the switch assembly against flux penetration from its topside.
防止助焊剂从开关的顶端渗入
- (3) Please have the products keep in close status and the storage time is 90 days guaranty after delivering the goods at most.
交货后保证开关处于封密状态并库存时间 90 天以下

12. Reel Packaging 盘装

12.1 Scope 范围

This specification covers the requirements of the reel packaging for SMT standard type of tactile switch. 该规范包含 SMT 标准型轻触开关的绕带封装的要求

12.2 Packaging Materials 封装材料

Item	项目	Description	说明
Package	包装	Cartons	卡通箱
Reel	转轴	Delete Cartons	可降解箱
Carrier Tape	载带	Polypropylene	聚丙烯

12.3 Packaging Quantity 封装数量

12.3.1 The number of the reels. 转轴数量

Twenty (20) reels at maximum. Which contain 60K pcs switches

Shall be packed in a package. 一箱装 20 盘,有 100K 只产品

12.3.2 The number of the switches. 产品数量

3000 pcs switches shall be packed in a reel. 一个转轴包 5000 只产品

12.3.3 It should be noted that we regard two cartons 对出口包装需注意用两个箱子包装 mentioned above as on package for export.

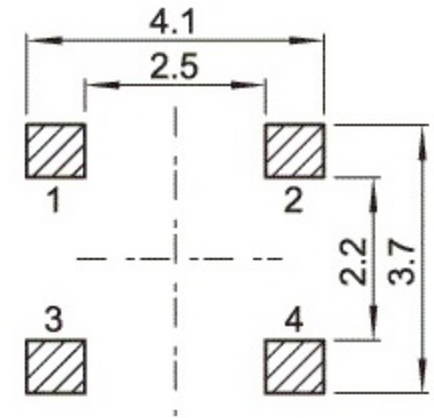
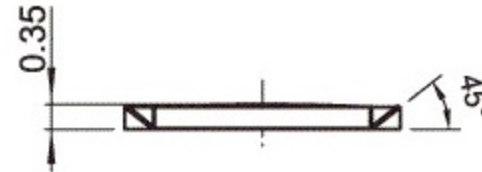
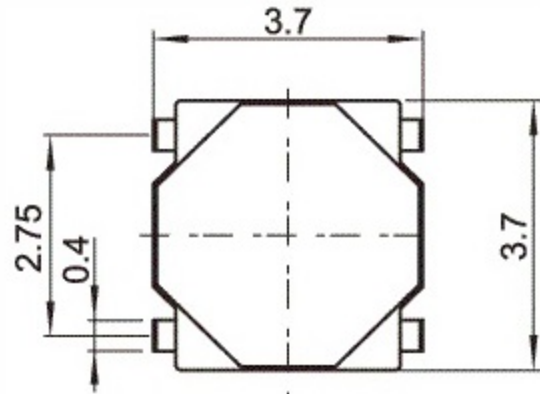

Tact switch technical parameters:

1. Rated load: DC 12V 50mA
2. Contact resistance: $\leq 100\text{m}\Omega$
3. Insulation resistance: $\geq 100\text{m}\Omega$ DC250V
4. Operating temperature: $-25^{\circ}\text{C}+80^{\circ}\text{C}$
5. Use humidity: $\leq 85\%\text{RH}$

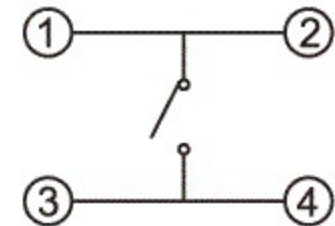

⑤	Terminal	—	4	Brass(0.30t)	Plating silver	—
④	Contact	—	1	F.Ag/SUS	—	—
③	Base	—	1	PA46	Black	—
②	Cover	—	1	SPCC	Plating Nickel	—
①	Keystoke	—	1	PA46	Black	—
ITEM	PART NAME	TER'NO.	QTY.	MATERIAL	FINISHING	REMARK



APPROVALS		DATE	三佐部品【中国】股份有限公司 SAMZO PARTS [CHINA] LIMITED BY SHARE LTD			
DRAWN	J.X.Zhang	2013/5/30	TITLE:		TACT SWITCHES	
CHECKED			PART NO.		T3XXX-XX4E-X0	
APPROVALS			UNIT: mm	SCALE: 1:1	PROJ:	
TOLERANCES ARE		ANGLE	DRAWING NO.	SHEET 1 OF 1		
30~以上	± 0.30	$\pm 2^{\circ}$				
10~30	± 0.20					
5~10	± 0.15					
~ 5	± 0.10					

ECN NO.	REV.	DATE.	DESCRIPTION.	CHANGE.	CHECK.	APPRO.
	A		NEW			