

Active module - VIP-8RPT-24DC/21/DO/FU/PLC - 2903601

Please be informed that the data shown in this PDF Document is generated from our Online Catalog. Please find the complete data in the user's documentation. Our General Terms of Use for Downloads are valid (<http://phoenixcontact.com/download>)



VARIOFACE Professional output module with eight channels, each with a pluggable 1 PDT relay and fuse, for 24 V DC

Your advantages

- ✓ Slim overall width of just 87.6 mm
- ✓ LED status indicator per signal path and supply voltage
- ✓ Polarity protection diode
- ✓ Fuse per output circuit as short-circuit protection
- ✓ Plug-in miniature relays each with a PDT contact



Key Commercial Data

Packing unit	1 pc
GTIN	 4 046356 948159
GTIN	4046356948159
Weight per Piece (excluding packing)	320.000 g
Custom tariff number	85369010
Country of origin	United States

Technical data

Note

Utilization restriction	EMC: class A product, see manufacturer's declaration in the download area
-------------------------	---

Dimensions

Width	87.6 mm
Height	109.8 mm

Active module - VIP-8RPT-24DC/21/DO/FU/PLC - 2903601

Technical data

Dimensions

Depth	63 mm
-------	-------

Ambient conditions

Ambient temperature (operation)	-20 °C ... 60 °C
Ambient temperature (storage/transport)	-20 °C ... 70 °C

Input data

Nominal input voltage U_N	24 V DC
Input voltage range in reference to U_N	0.9 ... 1.1
Typical input current at U_N	9 mA
Typical response time	5 ms
Typical release time	8 ms
Type of protection	Free-wheeling diode
Protective circuit/component	Damping diode
Operating voltage display	Green LED
Status display/channel	Yellow LED

Output data

Contact type	Single contact, 1-PDT
Contact material	AgSnO
Maximum switching voltage	250 V AC/DC
Minimum switching voltage	12 V AC/DC
Limiting continuous current	5 A (observe derating)
Min. switching current	10 mA
Interrupting rating (ohmic load) max.	120 W (24 V DC)
	20 W (48 V DC)
	18 W (60 V DC)
	23 W (110 V DC)
	40 W (220 V DC)
	1250 VA (250 V AC)
Error detection (line break / short-circuit)	no

General

No. of channels	8
Mechanical service life	2×10^7 cycles
Operating mode	100% operating factor
Mounting position	any
Assembly instructions	In rows with zero spacing
Color	gray

Active module - VIP-8RPT-24DC/21/DO/FU/PLC - 2903601

Technical data

Connection data

Connection name	Controller level
Connection method	IDC/FLK pin strip
Number of connections	1
Number of positions	14
Pitch	2.54 mm

Connection data 2

Connection name	Field level
Connection method	Push-in connection
Stripping length	8 mm
Conductor cross section solid	0.14 mm ² ... 2.5 mm ²
Conductor cross section flexible	0.14 mm ² ... 2.5 mm ²
Conductor cross section AWG	26 ... 14

Supported controller

Controller	SIEMENS S7-1500
- suitable I/O card	6ES7 522-1BH00-0AB0
	6ES7 522-1BH01-0AB0
	6ES7 522-1BL00-0AB0
	6ES7 522-1BL01-0AB0
Controller	ABB S800 I/O
- suitable I/O card	DO810
	DO840
Controller	ALLEN-BRADLEY ControlLogix
- suitable I/O card	1756-OB32
	1756-OB16E
Controller	ALLEN-BRADLEY PLC 5
- suitable I/O card	1771 OBN
Controller	ALLEN-BRADLEY SLC 500
- suitable I/O card	1746 OB 32
Controller	Emerson DeltaV
- suitable I/O card	VE4002S1T1B3
	VE4002S1T2B3
	VE4002S1T2B3 Series 2
	VE4002S1T2B6
Controller	GE-FANUC RX3i
- suitable I/O card	IC694MDL754
Controller	HONEYWELL Experion PKS C200

Active module - VIP-8RPT-24DC/21/DO/FU/PLC - 2903601

Technical data

Supported controller

- suitable I/O card	TC-ODD 321
Controller	MITSUBISHI MELSEC L
- suitable I/O card	LY41PT1P
	LY42PT1P
Controller	MITSUBISHI MELSEC Q
- suitable I/O card	QY81P
	QY82P
Controller	SIEMENS S7-300 / ET 200 M
- suitable I/O card	CPU 313C-2DP
	CPU 314C-2DP
	CPU 314C-2PtP
	6ES7 322-1BH01-0AA0
	6ES7 322-1BL00-0AA0
	6ES7 323-1BH01-0AA0
	6ES7 323-1BL00-0AA0
	CPU 313C
	CPU 313C-2PtP
Controller	SIEMENS S7-400
- suitable I/O card	6ES7 422-1BL00-0AA0
	6ES7 422-7BL00-0AB0

Standards and Regulations

Connection in acc. with standard	CSA
Standards/regulations	DIN EN 50178

Environmental Product Compliance

REACH SVHC	Lead 7439-92-1
China RoHS	Environmentally Friendly Use Period = 50 years
	For details about hazardous substances go to tab "Downloads", Category "Manufacturer's declaration"

Drawings

Active module - VIP-8RPT-24DC/21/DO/FU/PLC - 2903601

Diagram

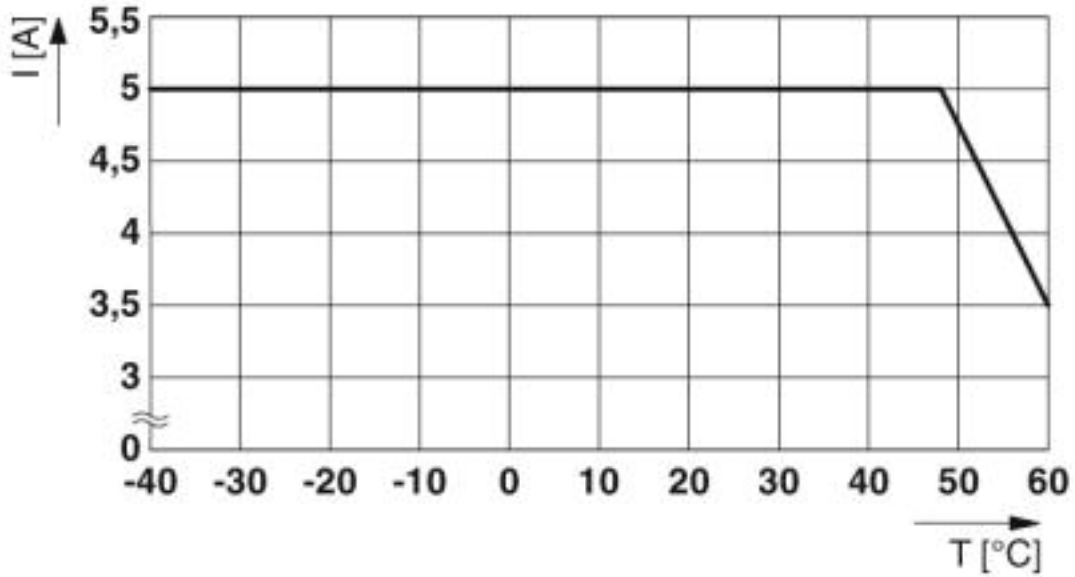

Circuit diagram

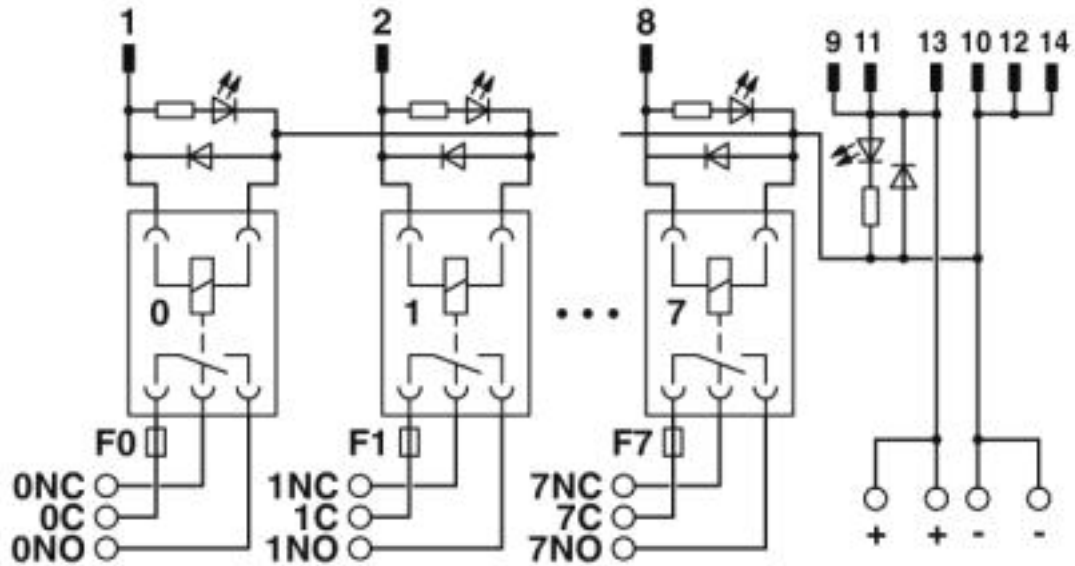

Classifications

eCl@ss

eCl@ss 4.0	27371100
eCl@ss 4.1	27371100

Active module - VIP-8RPT-24DC/21/DO/FU/PLC - 2903601

Classifications

eCl@ss

eCl@ss 5.0	27371000
eCl@ss 5.1	27371000
eCl@ss 6.0	27371000
eCl@ss 7.0	27141152
eCl@ss 8.0	27141152
eCl@ss 9.0	27141152

ETIM

ETIM 4.0	EC002780
ETIM 5.0	EC002780
ETIM 6.0	EC002780
ETIM 7.0	EC002780

UNSPSC

UNSPSC 6.01	30211916
UNSPSC 7.0901	39121515
UNSPSC 11	39121515
UNSPSC 12.01	39121515
UNSPSC 13.2	39121432
UNSPSC 18.0	39121432
UNSPSC 19.0	39121432
UNSPSC 20.0	39121432
UNSPSC 21.0	39121432

Approvals

Approvals

Approvals

CSA / UL Recognized / cUL Recognized / EAC / cULus Recognized

Ex Approvals

Approval details

Active module - VIP-8RPT-24DC/21/DO/FU/PLC - 2903601

Approvals

CSA		http://www.csagroup.org/services-industries/product-listing/	2122203
Nominal voltage UN		240 V	
Nominal current IN		5 A	
mm ² /AWG/kcmil		26-16	

UL Recognized		http://database.ul.com/cgi-bin/XYV/template/LISEXT/1FRAME/index.htm	FILE E 238705
Nominal voltage UN		250 V	
Nominal current IN		5 A	
mm ² /AWG/kcmil		26-14	

cUL Recognized		http://database.ul.com/cgi-bin/XYV/template/LISEXT/1FRAME/index.htm	FILE E 238705
Nominal voltage UN		250 V	
Nominal current IN		5 A	
mm ² /AWG/kcmil		26-14	

EAC		RU C- DE.A*30.B.01742
-----	---	--------------------------

cULus Recognized	
------------------	---

Accessories

Accessories

System cable

Active module - VIP-8RPT-24DC/21/DO/FU/PLC - 2903601

Accessories

Cable - FLK 14/EZ-DR/ 30/KONFEK - 2295729



Round cable set; connection 1: IDC/FLK socket strip (1x 14-position); connection 2: IDC/FLK socket strip (1x 14-position); cable length: 0.3 m

Cable - FLK 14/EZ-DR/ 50/KONFEK - 2288901



Round cable set; connection 1: IDC/FLK socket strip (1x 14-position); connection 2: IDC/FLK socket strip (1x 14-position); cable length: 0.5 m

Cable - FLK 14/EZ-DR/ 100/KONFEK - 2288914



Round cable set; connection 1: IDC/FLK socket strip (1x 14-position); connection 2: IDC/FLK socket strip (1x 14-position); cable length: 1 m

Cable - FLK 14/EZ-DR/ 150/KONFEK - 2288927



Round cable set; connection 1: IDC/FLK socket strip (1x 14-position); connection 2: IDC/FLK socket strip (1x 14-position); cable length: 1.5 m

Cable - FLK 14/EZ-DR/ 200/KONFEK - 2288930



Round cable set; connection 1: IDC/FLK socket strip (1x 14-position); connection 2: IDC/FLK socket strip (1x 14-position); cable length: 2 m

Active module - VIP-8RPT-24DC/21/DO/FU/PLC - 2903601

Accessories

Cable - FLK 14/EZ-DR/ 250/KONFEK - 2288943



Round cable set; connection 1: IDC/FLK socket strip (1x 14-position); connection 2: IDC/FLK socket strip (1x 14-position); cable length: 2.5 m

Cable - FLK 14/EZ-DR/ 300/KONFEK - 2288956



Round cable set; connection 1: IDC/FLK socket strip (1x 14-position); connection 2: IDC/FLK socket strip (1x 14-position); cable length: 3 m

Cable - FLK 14/EZ-DR/ 350/KONFEK - 2288969



Round cable set; connection 1: IDC/FLK socket strip (1x 14-position); connection 2: IDC/FLK socket strip (1x 14-position); cable length: 3.5 m

Cable - FLK 14/EZ-DR/ 400/KONFEK - 2288972



Round cable set; connection 1: IDC/FLK socket strip (1x 14-position); connection 2: IDC/FLK socket strip (1x 14-position); cable length: 4 m

Cable - FLK 14/EZ-DR/ 450/KONFEK - 2290847



Round cable set; connection 1: IDC/FLK socket strip (1x 14-position); connection 2: IDC/FLK socket strip (1x 14-position); cable length: 4.5 m

Active module - VIP-8RPT-24DC/21/DO/FU/PLC - 2903601

Accessories

Cable - FLK 14/EZ-DR/ 500/KONFEK - 2290834



Round cable set; connection 1: IDC/FLK socket strip (1x 14-position); connection 2: IDC/FLK socket strip (1x 14-position); cable length: 5 m

Cable - FLK 14/EZ-DR/ 550/KONFEK - 2290850



Round cable set; connection 1: IDC/FLK socket strip (1x 14-position); connection 2: IDC/FLK socket strip (1x 14-position); cable length: 5.5 m

Cable - FLK 14/EZ-DR/ 600/KONFEK - 2290863



Round cable set; connection 1: IDC/FLK socket strip (1x 14-position); connection 2: IDC/FLK socket strip (1x 14-position); cable length: 6 m

Cable - FLK 14/EZ-DR/ 800/KONFEK - 2299563



Round cable set; connection 1: IDC/FLK socket strip (1x 14-position); connection 2: IDC/FLK socket strip (1x 14-position); cable length: 8 m

Cable - FLK 14/EZ-DR/1000/KONFEK - 2299576



Round cable set; connection 1: IDC/FLK socket strip (1x 14-position); connection 2: IDC/FLK socket strip (1x 14-position); cable length: 10 m

Active module - VIP-8RPT-24DC/21/DO/FU/PLC - 2903601

Accessories

Cable - FLK EZ-DR.../.../... - 2295059



Round cable, with preassembly, not shielded, variable cable length

Cable - FLK 14/EZ-DR/ 50/KONFEK/S - 2296977



Assembled shielded round cable; connection 1: IDC/FLK socket strip (1x 14-position); connection 2: IDC/FLK socket strip (1x 14-position) (The braided shield is routed to a separate cable end.); cable length: 0.5 m

Cable - FLK 14/EZ-DR/ 100/KONFEK/S - 2296980



Assembled shielded round cable; connection 1: IDC/FLK socket strip (1x 14-position); connection 2: IDC/FLK socket strip (1x 14-position) (The braided shield is routed to a separate cable end.); cable length: 1 m

Cable - FLK 14/EZ-DR/ 200/KONFEK/S - 2297002



Assembled shielded round cable; connection 1: IDC/FLK socket strip (1x 14-position); connection 2: IDC/FLK socket strip (1x 14-position) (The braided shield is routed to a separate cable end.); cable length: 2 m

Cable - FLK 14/EZ-DR/ 300/KONFEK/S - 2299013



Assembled shielded round cable; connection 1: IDC/FLK socket strip (1x 14-position); connection 2: IDC/FLK socket strip (1x 14-position) (The braided shield is routed to a separate cable end.); cable length: 3 m

Active module - VIP-8RPT-24DC/21/DO/FU/PLC - 2903601

Accessories

Cable - FLK 14/EZ-DR/ 400/KONFEK/S - 2299026



Assembled shielded round cable; connection 1: IDC/FLK socket strip (1x 14-position); connection 2: IDC/FLK socket strip (1x 14-position) (The braided shield is routed to a separate cable end.); cable length: 4 m

Cable - FLK 14/EZ-DR/ 600/KONFEK/S - 2299039



Assembled shielded round cable; connection 1: IDC/FLK socket strip (1x 14-position); connection 2: IDC/FLK socket strip (1x 14-position) (The braided shield is routed to a separate cable end.); cable length: 6 m

Cable - FLK 14/EZ-DR/ 800/KONFEK/S - 2299042



Assembled shielded round cable; connection 1: IDC/FLK socket strip (1x 14-position); connection 2: IDC/FLK socket strip (1x 14-position) (The braided shield is routed to a separate cable end.); cable length: 8 m

Cable - FLK 14/EZ-DR/1000/KONFEK/S - 2299055



Assembled shielded round cable; connection 1: IDC/FLK socket strip (1x 14-position); connection 2: IDC/FLK socket strip (1x 14-position) (The braided shield is routed to a separate cable end.); cable length: 10 m

Cable - FLK EZ-DR-S.../.../... - 2295046



Round cable, with preassembly, shielded, variable cable length

Active module - VIP-8RPT-24DC/21/DO/FU/PLC - 2903601

Accessories

Cable - FLK 14/EZ-DR/HF/ 50/KONFEK - 2305952



Assembled, halogen-free round cable; connection 1: IDC/FLK socket strip (1x 14-position); connection 2: IDC/FLK socket strip (1x 14-position); cable length: 0.5 m

Cable - FLK 14/EZ-DR/HF/ 100/KONFEK - 2305965



Assembled, halogen-free round cable; connection 1: IDC/FLK socket strip (1x 14-position); connection 2: IDC/FLK socket strip (1x 14-position); cable length: 1 m

Cable - FLK 14/EZ-DR/HF/ 150/KONFEK - 2305978



Assembled, halogen-free round cable; connection 1: IDC/FLK socket strip (1x 14-position); connection 2: IDC/FLK socket strip (1x 14-position); cable length: 1.5 m

Cable - FLK 14/EZ-DR/HF/ 200/KONFEK - 2305981



Assembled, halogen-free round cable; connection 1: IDC/FLK socket strip (1x 14-position); connection 2: IDC/FLK socket strip (1x 14-position); cable length: 2 m

Cable - FLK 14/EZ-DR/HF/ 250/KONFEK - 2305994



Assembled, halogen-free round cable; connection 1: IDC/FLK socket strip (1x 14-position); connection 2: IDC/FLK socket strip (1x 14-position); cable length: 2.5 m

Active module - VIP-8RPT-24DC/21/DO/FU/PLC - 2903601

Accessories

Cable - FLK 14/EZ-DR/HF/ 300/KONFEK - 2304759



Assembled, halogen-free round cable; connection 1: IDC/FLK socket strip (1x 14-position); connection 2: IDC/FLK socket strip (1x 14-position); cable length: 3 m

Cable - FLK 14/EZ-DR/HF/ 400/KONFEK - 2304762



Assembled, halogen-free round cable; connection 1: IDC/FLK socket strip (1x 14-position); connection 2: IDC/FLK socket strip (1x 14-position); cable length: 4 m

Cable - FLK 14/EZ-DR/HF/ 500/KONFEK - 2304717



Assembled, halogen-free round cable; connection 1: IDC/FLK socket strip (1x 14-position); connection 2: IDC/FLK socket strip (1x 14-position); cable length: 5 m

Cable - FLK 14/EZ-DR/HF/ 600/KONFEK - 2306003



Assembled, halogen-free round cable; connection 1: IDC/FLK socket strip (1x 14-position); connection 2: IDC/FLK socket strip (1x 14-position); cable length: 6 m

Cable - FLK 14/EZ-DR/HF/ 700/KONFEK - 2314011



Assembled, halogen-free round cable; connection 1: IDC/FLK socket strip (1x 14-position); connection 2: IDC/FLK socket strip (1x 14-position); cable length: 7 m

Active module - VIP-8RPT-24DC/21/DO/FU/PLC - 2903601

Accessories

Cable - FLK 14/EZ-DR/HF/ 800/KONFEK - 2314024



Assembled, halogen-free round cable; connection 1: IDC/FLK socket strip (1x 14-position); connection 2: IDC/FLK socket strip (1x 14-position); cable length: 8 m

Cable - FLK 14/EZ-DR/HF/1000/KONFEK - 2314037



Assembled, halogen-free round cable; connection 1: IDC/FLK socket strip (1x 14-position); connection 2: IDC/FLK socket strip (1x 14-position); cable length: 10 m

Cable - FLK 14-EZ-DR-HF/... - 2314040



Assembled, halogen-free round cable; connection 1: IDC/FLK socket strip (1x 14-position); connection 2: IDC/FLK socket strip (1x 14-position); cable length: variable

Terminal marking

Marker for terminal blocks - UC-TM 4 - 0818111



Marker for terminal blocks, Sheet, white, unlabeled, can be labeled with: BLUEMARK ID COLOR, BLUEMARK ID, BLUEMARK CLED, PLOTMARK, CMS-P1-PLOTTER, mounting type: snap into tall marker groove, for terminal block width: 4.2 mm, lettering field size: 3.6 x 10.5 mm, Number of individual labels: 120

Marker for terminal blocks - UC-TM 6 - 0818085



Marker for terminal blocks, Sheet, white, unlabeled, can be labeled with: BLUEMARK ID COLOR, BLUEMARK ID, BLUEMARK CLED, PLOTMARK, CMS-P1-PLOTTER, mounting type: snap into tall marker groove, for terminal block width: 6.2 mm, lettering field size: 5.6 x 10.5 mm, Number of individual labels: 80

Active module - VIP-8RPT-24DC/21/DO/FU/PLC - 2903601

Accessories

Marker for terminal blocks - UCT-TM 6 - 0828736



Marker for terminal blocks, Sheet, white, unlabeled, can be labeled with: TOPMARK NEO, TOPMARK LASER, BLUEMARK ID COLOR, BLUEMARK ID, BLUEMARK CLED, THERMOMARK PRIME, THERMOMARK CARD 2.0, THERMOMARK CARD, mounting type: snap into tall marker groove, for terminal block width: 6.2 mm, lettering field size: 5.6 x 10.5 mm, Number of individual labels: 60

Zack marker strip - ZB 5,08:UNBEDRUCKT - 0809793



Zack marker strip, Strip, white, unlabeled, can be labeled with: PLOTMARK, CMS-P1-PLOTTER, mounting type: snap into tall marker groove, for terminal block width: 5.08 mm, lettering field size: 4.98 x 10.5 mm, Number of individual labels: 10

Zack marker strip - ZB 22:UNBEDRUCKT - 0811862



Zack marker strip, Strip, white, unlabeled, can be labeled with: PLOTMARK, CMS-P1-PLOTTER, mounting type: snap into tall marker groove, for terminal block width: 22 mm, lettering field size: 10.5 x 21.8 mm, Number of individual labels: 4

Spare parts

Fuse set - FUSE/TE5/6.3A/T-10PCS - 2905605



Plug-in fuse (TE5[®]); nominal current: 6.3 A; tripping behavior: slow-blow (F)

Single relay - REL-MR- 24DC/21 - 2961105



Plug-in miniature power relay, with power contact, 1 PDT, input voltage 24 V DC

