

SPECIFICATIONS FOR TOP LED

MODEL:MK-PB1615RGB3C-010F(共阳)

(2022.04.27更新版本)

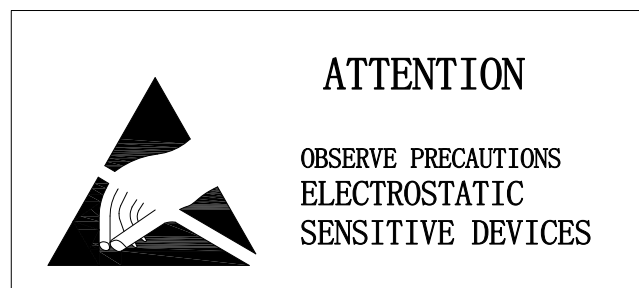

1、 Features

- Package (L/W/H) : 1.6 × 1.5 × 0.55 mm
- Color : Ultra Bright RGB Full Color
- Lens: Water Clear Flat Mold
- EIA STD package
- Meet ROHS, Green Product
- Compatible With SMT Automatic Equipment
- Compatible With Infrared Reflow Solder And Wave Solder Process

2、 Package Profile & Soldering PAD Suggested

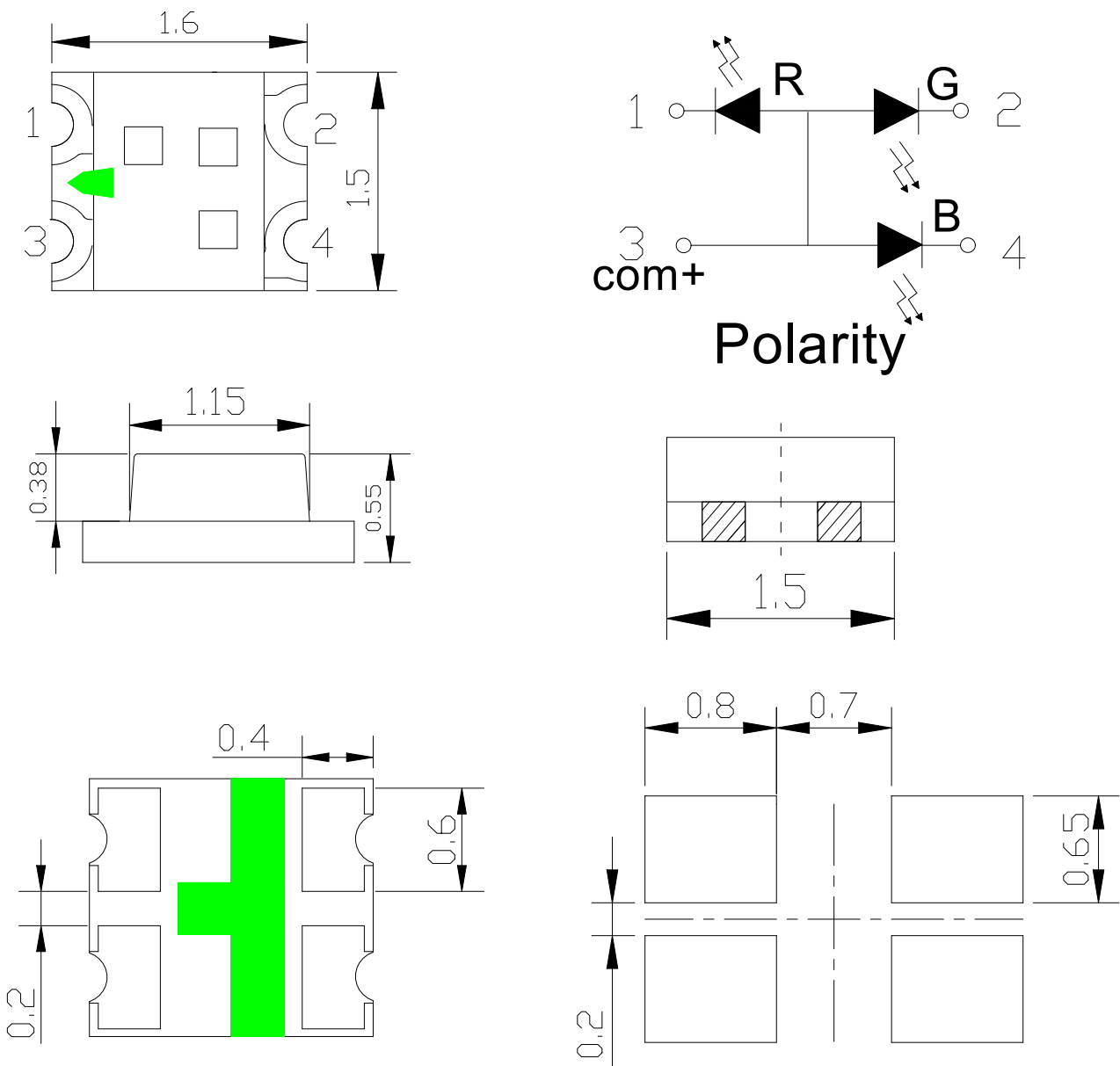

- Notes: 1. All dimensions are in millimeters ;
 2. Tolerance is ± 0.10 mm unless otherwise noted.

3、 Soldering Profile Suggested

3.1、 For Lead Solder

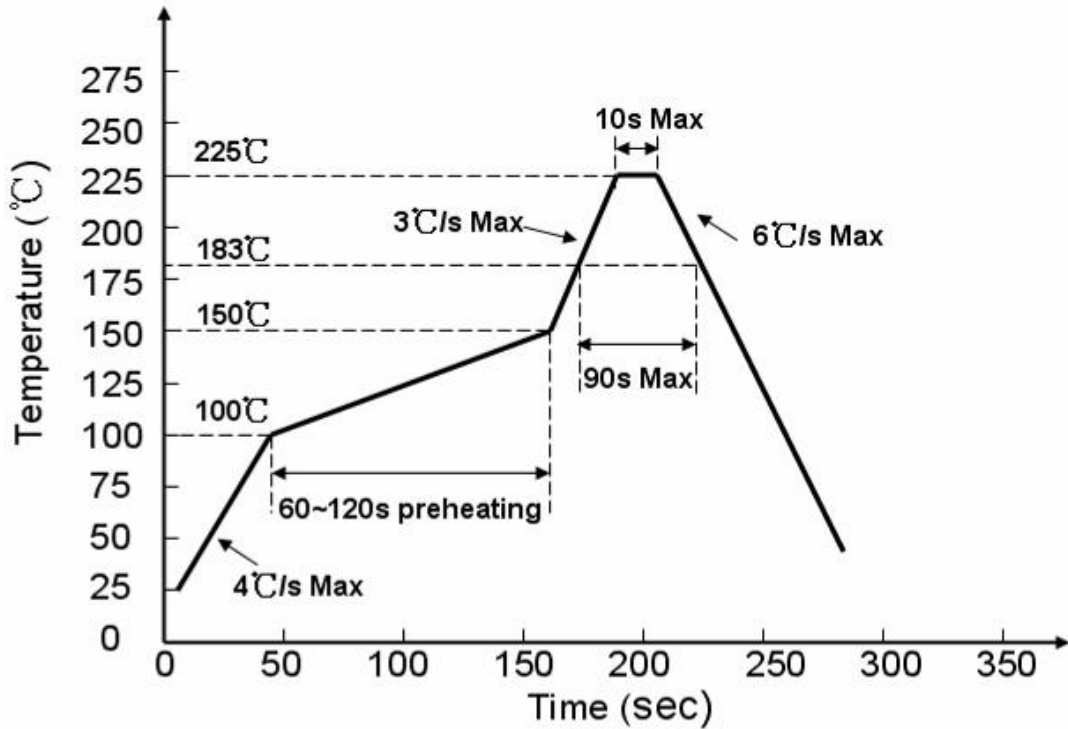

3.2、 For Lead Free Solder

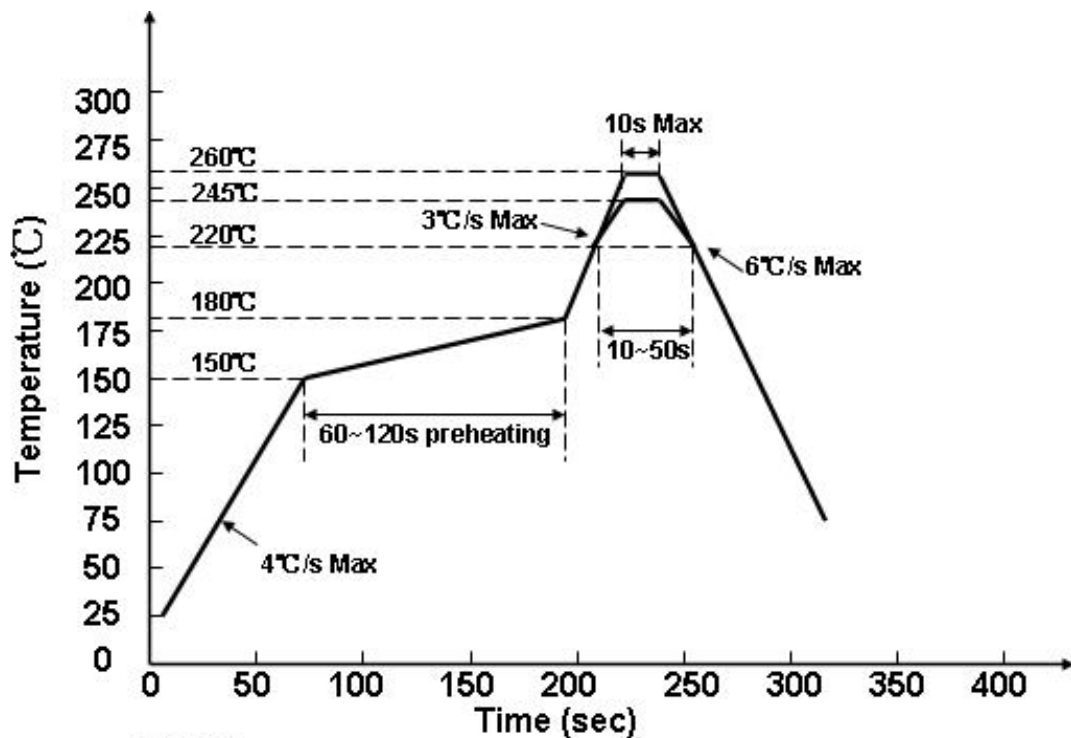

Notes:

We recommend the soldering temperature $245 \pm 5^\circ\text{C}$;

The maximum temperature should be limited to 260°C .

4. Absolute Maximum Ratings At Ta=25°C

Parameter	Symbol	Rating		Unit
Power Dissipation	Pd	R	70	mW
		G	90	
		B	90	
Peak Forward Current (1/10 Duty Cycle, 0.1ms Pulse Width)	I _{FP}	R	70	mA
		G	100	
		B	100	
DC Forward Current	I _F	R	30	mA
		G	30	
		B	30	
Reverse Voltage	V _R	R	5	V
		G	5	
		B	5	
Operating Temperature Range	T _{opr}	-30°C ~ +85°C		
Storage Temperature Range	T _{stg}	-40°C ~ +90°C		
Soldering Condition	T _{sol}	Reflow soldering : 260°C For 5 Seconds Hand soldering: 300°C For 3 Seconds		

5、 Electrical Optical Characteristics At Ta=25℃

Parameter	Symbol	Color	Min.	Typ.	Max.	Unit	Test Condition
Luminous Intensity	IV	R	---	100	---	mcd	IF = 20mA
		G	---	300	---		
		B	---	90	---		
Dominant Wavelength	λ_d	R	---	624	---	nm	IF=20mA
		G	---	525	---		
		B	---	468	---		
Peak Wavelength	λ_p	R	---	630	---	nm	IF=20mA
		G	---	530	---		
		B	---	470	---		
Spectral Line Half-Width	$\Delta\lambda$	R	---	20	---	nm	IF=20mA
		G	---	35	---		
		B	---	30	---		
Forward Voltage	VF	R	1.8	---	2.6	V	IF=20mA
		G	2.8	---	3.6		
		B	2.8	---	3.6		
Reverse Current	IR	R	---	---	10	uA	VR=5V
		G	---	---	10		
		B	---	---	10		
Viewing Angle	2 θ 1/2	---	---	120	---	deg	IF = 20mA

Notes: 1. Luminous intensity is measured with a light sensor and filter combination that approximates the CIE eye-response curve.

2. θ 1/2 is the off-axis angle at which the luminous intensity is half the axial luminous intensity.

3. The dominant wavelength, λ_d is derived from the CIE chromaticity diagram and represents the single wavelength which defines the color of the device.

6. Typical Electrical-Optical Characteristics Curves

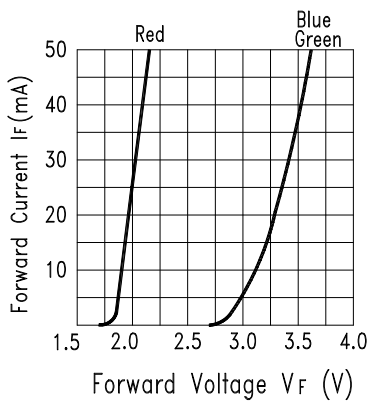
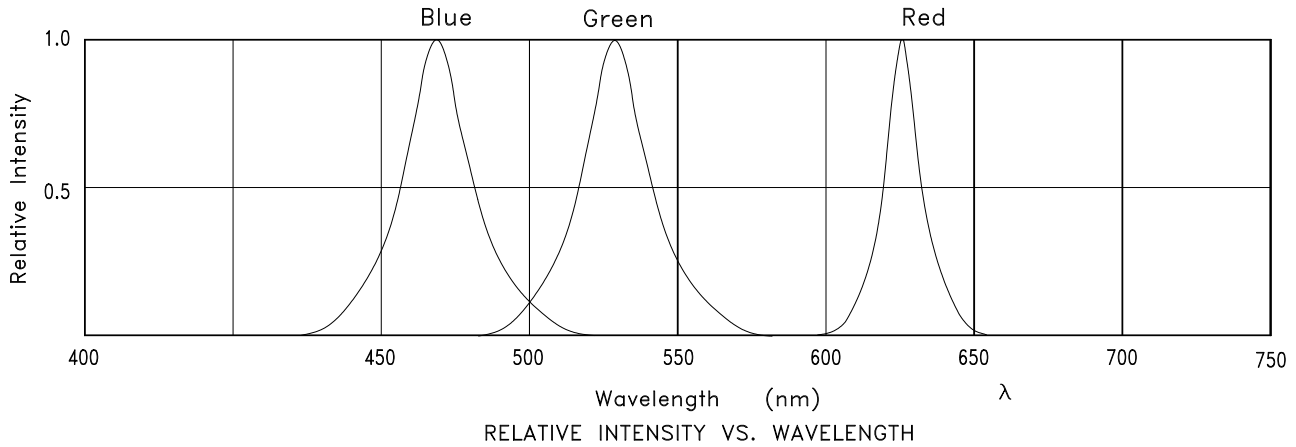

Fig.2 Forward Current vs. Forward Voltage

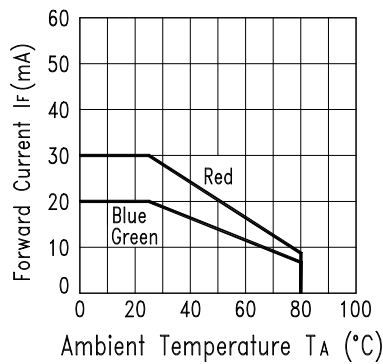

Fig.3 Forward Current Derating Curve

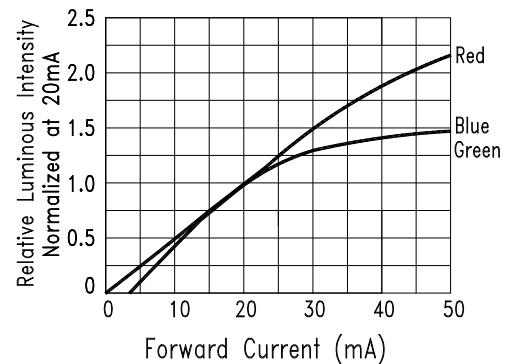

Fig.4 Relative Luminous Intensity vs. Forward Current

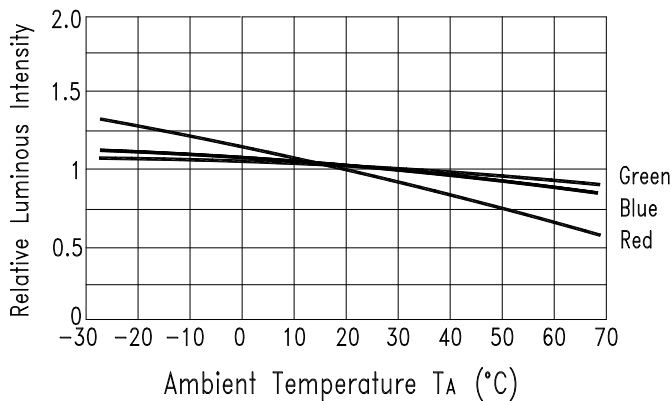

Fig.5 Luminous Intensity vs. Ambient Temperature

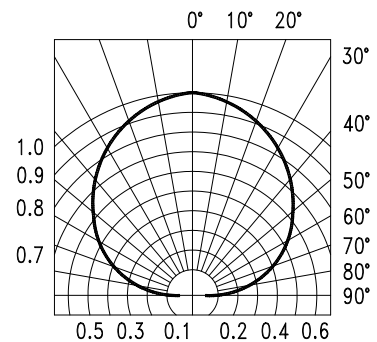

Fig.6 Spatial Distribution

7、 Label explanation

CAT: Luminous Intensity Rank (unit : mcd)

HUE: Dominant Wavelength Rank (unit : nm)

REF: Forward Voltage Rank (unit : V)

Rank Tolerance:

a. Luminous Intensity: $\pm 15\%$

b. HUE: $\pm 1\text{nm}$

c. Forward Voltage: $\pm 0.1\text{V}$

8、 Reel Dimensions:

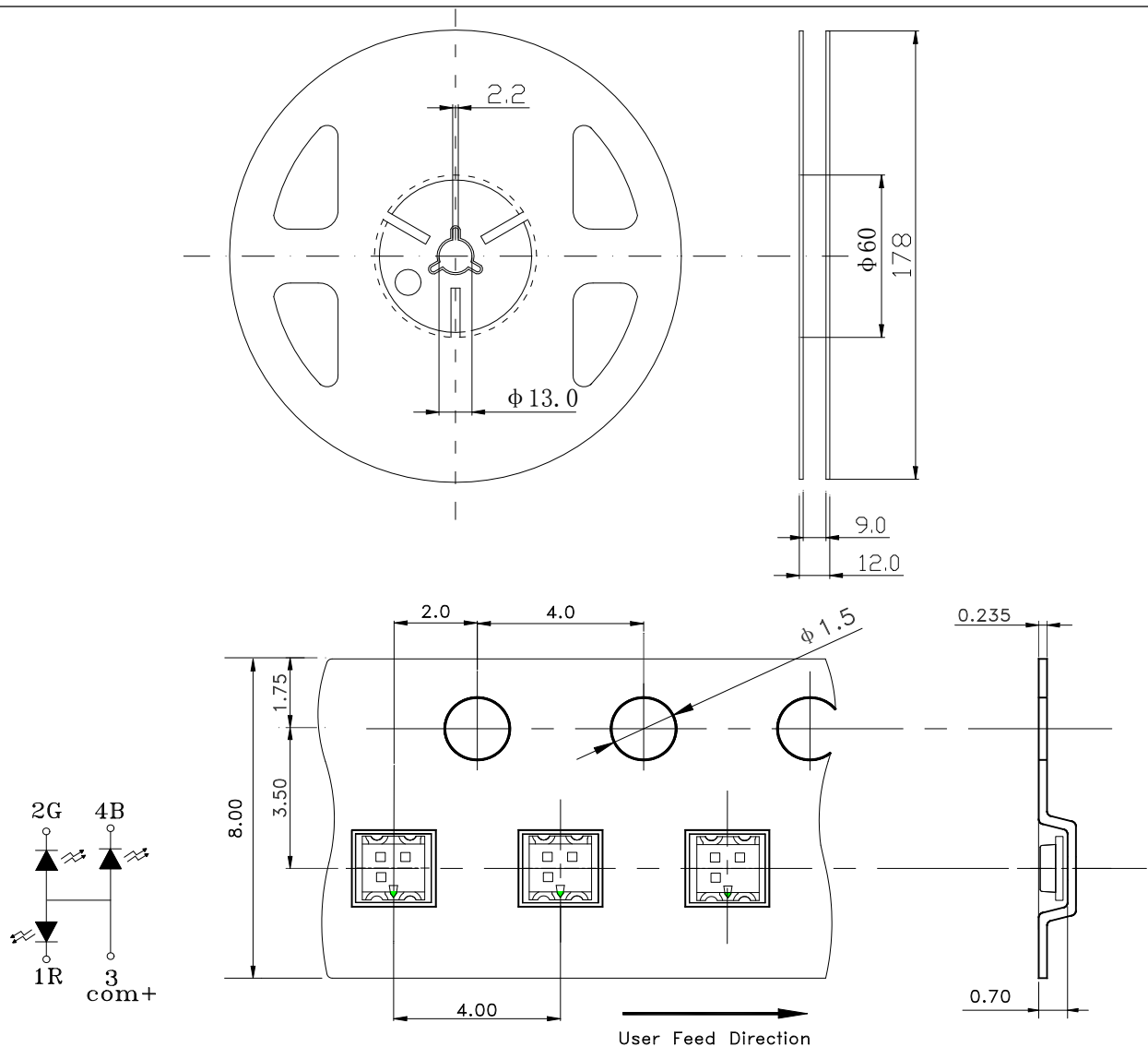

- Notes: 1. All dimensions are in millimeters ;
 2. Tolerance is $\pm 0.10\text{ mm}$ unless otherwise noted.

9、 Tape Leader & Trailer Dimensions And Reel

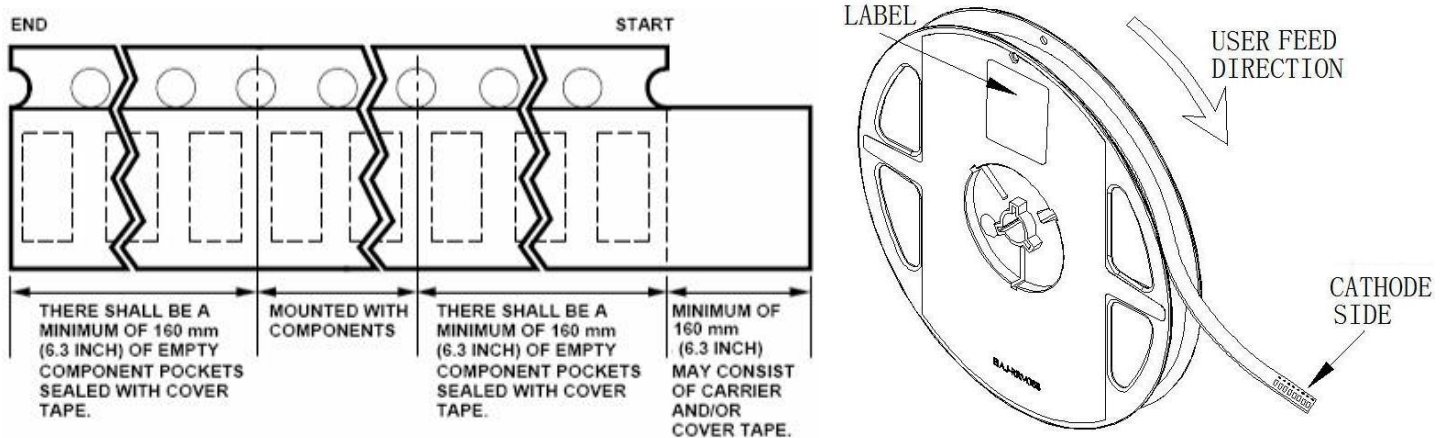

10、 Moisture Resistant Packaging:

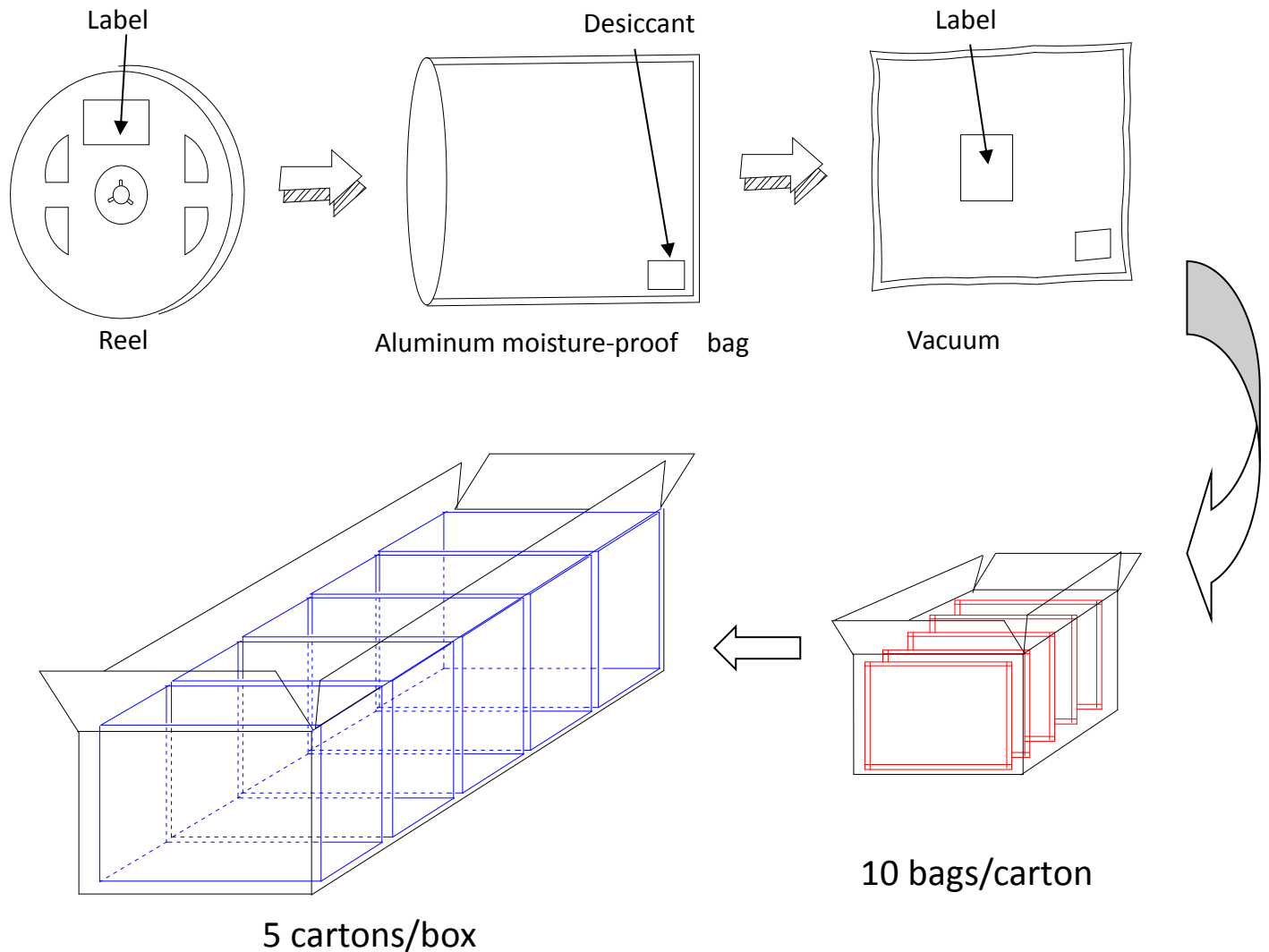

11、 Reliability Test

地址：深圳市龙华区福城街道汇隆智造空间B栋9楼

地址：东莞市凤岗镇官井头滨河南路1号

TEL : +86-755-29763500 29763900

FAX : +86-755-29763589

WWW.SYLED.CN

Classification	Test Item	Test Condition	Reference Standard	Reference Standard
Endurance Test	Operation Life	Ta= Under Room Temperature As Per Data Sheet Maximum Rating	1000HRS (-24HRS,+72HRS)*@20mA	MIL-STD-750D:1026 MIL-STD-883D:1005 JIS C 7021:B-1
	High Temperature, High Humidity Storage	IR-Reflow In-Board, 2 Times Ta= 65±5°C,RH= 90~95%	240HRS±2HRS	MIL-STD-202F:103B JIS C 7021:B-11
	High Temperature Storage	Ta= 105±5°C	1000HRS (-24HRS,+72HRS)	MIL-STD-883D:1008 JIS C 7021:B-10
	Low Temperature Storage	Ta= -55±5°C	1000HRS (-24HRS,+72HRS)	JIS C 7021:B-12
Environmental Test	Temperature Cycling	105°C ~ 25°C ~ -55°C ~ 25°C 30mins 5mins 30mins 5mins	10 Cycles	MIL-STD-202F:107D MIL-STD-750D:1051 MIL-STD-883D:1010 JIS C 7021:A-4
	Thermal Shock	IR-Reflow In-Board, 2 Times 85 ± 5°C ~ -40°C ± 5°C 10mins 10mins	10 Cycles	MIL-STD-202F:107D MIL-STD-750D:1051 MIL-STD-883D:1011
	Solder Resistance	T.sol= 260 ± 5°C	10 ± 1secs	MIL-STD-202F:210A MIL-STD-750D:2031 JIS C 7021:A-1
	IR-Reflow Normal Process	Ramp-up rate(183°C to Peak) +3°C/ second max Temp. maintain at 125(±25)°C 120 seconds max Temp. maintain above 183°C 60-150 seconds Peak temperature range 235°C+5/-0°C Time within 5°C of actual Peak Temperature (tp) 10-30 seconds Ramp-down rate +6°C/second max	-----	MIL-STD-750D:2031.2 J-STD-020C
	IR-Reflow Pb Free Process	Ramp-up rate(217°C to Peak) +3°C/ second max Temp. maintain at 175(±25)°C 180 seconds max Temp. maintain above 217°C 60-150 seconds Peak temperature range 260°C+0/-5°C Time within 5°C of actual Peak Temperature (tp) 20-40 seconds Ramp-down rate +6°C/second max	-----	MIL-STD-750D:2031.2 J-STD-020C
Solderability	T.sol= 235 ± 5°C Immersion rate 25±2.5 mm/sec Coverage ≧ 95% of the dipped surface	Immersion time 2±0.5 sec	MIL-STD-202F:208D MIL-STD-750D:2026 MIL-STD-883D:2003 IEC 68 Part 2-20 JIS C 7021:A-2	

12、Cautions

Application

1. A LED is a current-operated device. The slight shift of voltage will cause big change of current, which will damage LEDs. Customer should use resistors in series for the Over-Current-Proof.
2. In order to ensure intensity uniformity on multiple LEDs connected in parallel in an application, it is recommended to use individual resistor separately, as shown in Circuit A below. The brightness of each LED shown in Circuit B might appear difference due to the differences in the I-V characteristics of those LEDs.

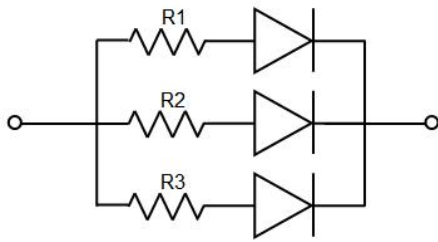

Circuit model A

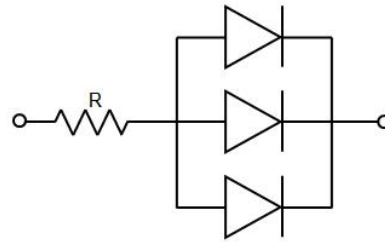

Circuit model B

3. High temperature may reduce LEDs' intensity and other performances, so keeping it away from heat source to get good performance is necessary.

Storage

1. Before opening original package, it is recommended to store them in the following environment:

Temperature: 5°C~30°C

Humidity: 85%RH max.

2. After opening original package, the storage ambient for the LEDs should be in 5~30°C temperature and 60% or less relative humidity.
3. In order to avoid moisture absorption, it is recommended that the LEDs that out of the original package should be stored in a sealed container with appropriate desiccant, or in desiccators with nitrogen ambient.
4. The LEDs should be used within 168hrs (7 days) after opening the package. Once been mounted, soldering should be quick.
5. If the moisture absorbent material (silica gel) has faded away or the LEDs stored out of original package for more than 168hrs (7 days), baking treatment should be performed using the conditions: 60°C at least 24 hours.

ESD (Electrostatic Discharge)-Protection

A LED (especially the Blue、White and Green product) is an ESD sensitive component, and static electricity or power surge will damage the LED. ESD-damaged LEDs will exhibit abnormal characteristics such as high reverse leakage current, low forward voltage, or “no light-up” at low currents, etc.

Some advice as below should be noticed:

1. A conductive wrist strap or anti-electrostatic glove should be worn when handling these LEDs.

地址：深圳市龙华区福城街道汇隆智造空间B栋9楼

地址：东莞市凤岗镇官井头滨河南路1号

TEL : +86-755-29763500

29763900

FAX : +86-755-29763589

WWW.SYLED.CN

2. All devices, equipment, machinery, work tables and storage racks, etc. must be properly grounded.
3. Use anti-static package or boxes to carry and storage LEDs. And ordinary plastic package or boxes is forbidden to use.
4. Use ionizer to neutralize the static charge during handling or operating.
5. All surfaces and objects within 1 ft close to LEDs measure less than 100V.

Cleaning

Use alcohol-based cleaning solvents such as IPA (isopropyl alcohol) to clean LEDs if necessary.

Soldering

1. Soldering condition refer to the draft “Soldering Profile Suggested” on page 1.
2. Reflow soldering should not be done more than 2 times.
3. Manual soldering is only suggested on repair and rework. The maximum soldering temperature should not exceed 300°C within 3 sec. And the maximum capacity of soldering iron is 30W in power.
4. During the soldering process, do not touch the lens at high temperature.
5. After soldering, any mechanical force on the lens or any excessive vibration shall not be accepted to apply, also the circuit board shall not be bent as well.

Others

1. The LEDs described here are intended to be used for ordinary electronic equipment (such as office equipment, communication equipment and household applications). Consult Pinkpurple’s Sales in advance for the applications in which exceptional reliability is required, particularly when the failure or malfunction of the LEDs may directly jeopardize life or health. (such as in aviation, transportation, traffic control equipment, medical and life support systems and safety devices).
2. The light output from the high luminous intensity LEDs may cause injury to human eyes when viewed directly.
3. The appearance and specifications of the product may be modified for improvement without prior notice.