

Recommend P.C.B. Layout(T=0.80mm)
Tolerance Unspecified±0.05mm

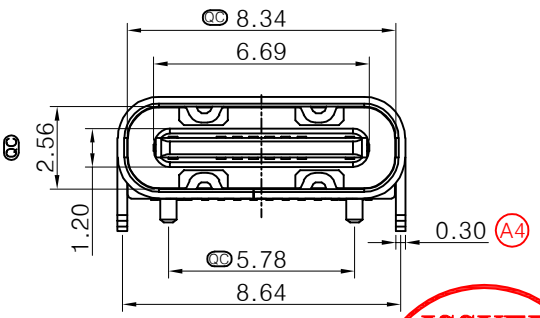
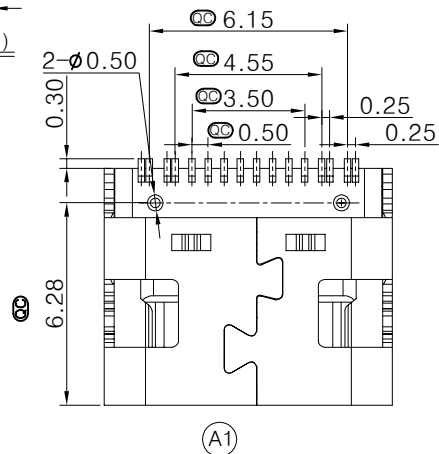
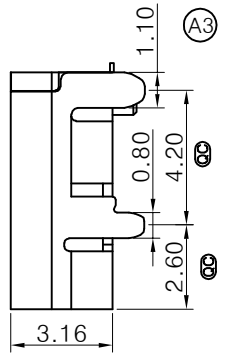
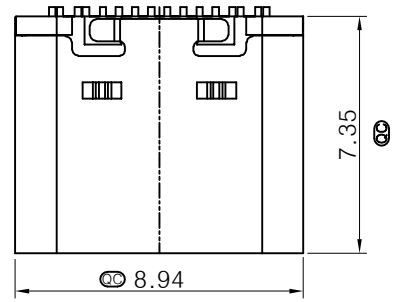

A1	GND	B12	GND
A4	VBUS	B9	VBUS
A5	CC1	B8	SBU2
A6	DP1	B7	DN2
A7	DN1	B6	DP2
A8	SBU1	B5	CC2
A9	VBUS	B4	VBUS
A12	GND	B1	GND
PIN	SIGNAL NAME	PIN	SIGNAL NAME

(A1) NOTES:

1.MATERIAL:

- 1.1 Housing:thermoplastic plastics
- 1.2 terminals:Copper Alloy
Gold plated in contact area:
Tin plated in termination
Nickel Plated overall
- 1.3 Shell:Steel&Copper Alloy
Nickel/Au Plated overall

2.characteristics:

- 2.1 Rating Voltage : 30V AC.
- 2.2 Rating Current:
5A for Vbus PIN;1.25A for Vconn PIN
- 2.3 Contact Resistance:40 mΩ MAX.
- 2.4 Insulation Resistance:100 MΩ MIN.
- 2.5 Withstanding Voltage:AC 100V
- 2.6 Mating force: 5~20N MAX
- 2.7 Extraction force:8~20N Min
- 2.8 Life test:10000Cycles MIN.
- 2.9 Temperature Range: -40℃~+ 105℃ .(A2)

(QC) Important Dimensions

Part Number:

43A E4A X X X X 0 H

Plating Code :

- 1-Selective gold flash over nickel
- 3-Selective 0.075um gold over nickel
- 5-Selective 0.125um gold over nickel
- 6-Selective 0.25um gold over nickel
- 7-Selective 0.375um gold over nickel
- 8-Selective 0.75um gold over nickel

Packaging options:

- 1-Tube packaging PVC
- 2-Tape &Reel packaging
- 3-pallet packaging

Insulator Color:

- 0-White 1-Black

Material (Insulator + shell) : (A2)

- 2-LCP + Brass
- B-LCP + SPCC



A4	Updated the drawing	15/05/25	Units	mm	Scale	3:1	Drawing By	Date
A3	Updated the drawing	14/05/25	Tolerance Unless				LC-Liu	2025/05/14
A2	Updated the drawing	13/05/25	Otherwise Specified				Revised By	Date
A1	Updated the drawing	26/11/24		.X ~ ±0.30			Lin-Wu	2025/05/14
A	RELEASED	16/11/18		.XX ~ ±0.25			Approval By	Date
REV	DESCRIPTION.	Date		.XXX ~ ±0.20			Kirby-Xiao	2025/05/14
				Angle ~ ± 3°				



LEYCONN ELECTRONICS CO.,LTD.
深圳市联益康电子有限公司
TEL: +86(755)26078616 FAX: 26070522

Sheet	1 of 1	Title	USB C TYPE 16P 板上四脚插板型	
Third Angle Projection		Part No.	43AE4AXXXX0H	REV A4

可靠性测试报告

Reliability Test Report

产品名称: TypeC/母座/DIP/16P/LCP/黑色/板上四角插板型/卷装

产品料号: 43AE4A12120H

测试项目: 可靠性测试

测试日期: 2025/9/1

深圳市联益康电子有限公司

LEYCN TECHNOLOGY (HK) CO LIMITED SHENZHEN LEYCONN ELECTRONICS CO.,LTD

地址: 深圳市寶安區石岩鎮塘頭大道宏發高新園7棟

Address: Building 7, Hongfa Hi-tech Park, Tangtou Avenue, Shiyan Town, Baoan District, Shenzhen

电话: +86 (755) 2607 8596 Ext:807

传真: +86 (755) 2607 8596

本测试报告版仅为深圳市联益康电子有限公司所有, 未经许可, 不得复制、复印、盗用、转发.

测试报告

物料编码	43AE4A12120H			测试日期	2025/9/1
测试设备型号	TH2511低电阻测试仪			测试数量	3pcs
测试项目	接触电阻			测试地点	实验室
测试条件	电流100mA MAX, 电压20mV MAX				
测试要求	接触阻抗 < 40mΩ				
测试数据	样品	1#	2#	3#	判定
	1	15.9	23.9	18.0	OK
	2	17.6	28.1	29.2	OK
	3	18.2	19.1	23.7	OK
	4	32.5	31.8	22.9	OK
	5	29.7	24.9	20.9	OK
	6	22.7	15.9	34.6	OK
	7	34.6	26.6	18.9	OK
	8	27.6	34.7	28.0	OK
	9	21.2	24.9	20.7	OK
	10	31.2	17.5	31.2	OK
	11	22.5	28.4	30.9	OK
	12	24.4	16.2	21.4	OK
	13	33.7	24.5	29.4	OK
	14	15.9	30.9	28.3	OK
	15	23.3	33.5	33.3	OK
	16	34.6	26.5	32.9	OK
	17	34.4	25.7	34.0	OK
	18	26.8	29.9	28.2	OK
	Max	34.6	34.7	34.6	OK
Min	15.9	15.9	18.0	OK	
Ave	25.9	25.7	27.0	OK	
判定	合格				
附图片:					
	<div style="border: 1px solid black; padding: 5px; display: inline-block;">接触电阻测试</div>				
拟制: 王学富	审核: 白明			核准: 田心满	

测试报告

物料编码	43AE4A12120H	测试日期	2025/9/1
测试设备型号	MS2670E绝缘耐压机	测试数量	3pcs
测试项目	绝缘电阻	测试地点	实验室
测试条件	使用500V/DC 作用在两个相邻的端子之间或端子与外壳之间, 持续60S;		
测试要求	绝缘电阻 > 100M Ω		
测试结果	样品测试时绝缘电阻 > 100M Ω		
判定	合格		
附图片:	 <p>绝缘耐压测试</p>		
拟制: 王学富	审核: 白明	核准: 田心满	

测试报告

物料编码	43AE4A12120H	测试日期	2025/9/1
测试设备型号	MS2670E绝缘耐压机	测试数量	3pcs
测试项目	耐电压测试	测试地点	实验室
测试条件	使用100V/AC作用在两个相邻的端子之间或端子与外壳之间, 持续60S;		
测试要求	无击穿, 无闪络, 无短路现象, 漏电流 < 0.5mA		
测试结果	样品测试时无击穿, 无闪络, 无短路现象, 漏电流 < 0.5mA		
判定	合格		
附图片:	 <p style="text-align: center;">绝缘耐压测试</p>		
拟制: 王学富	审核: 白明	核准: 田心满	

测试报告

物料编码	43AE4A12120H	测试日期	2025/9/1
测试设备型号	JK18040303全自动插拔力测试机	测试数量	3pcs
测试项目	插拔力测试	测试地点	实验室
测试条件	以12.5mm/min的速度, 插头与连接插座之间进行插拔		
测试要求	插入力: 5-20N MAX 拔出力: 8-20N Min		
测试结果	插入力: 14.3/12.9/12.8/11.6/12.6/13.6/12.5/9.9/10.1/10.2/14.8/12.5/11.6/11.2/10.9 拔出力: 15.1/15.2/13.9/13.2/12.7/12.6/12.3/11.4/12.6/13.6/10.6/10.7/10.9/12.2/12.3		
判定	合格		
附图片:			
	<div style="border: 1px solid black; padding: 5px; display: inline-block;">插拔力测试</div>		
拟制: 王学富	审核: 白明	核准: 田心满	

测试报告

物料编码	43AE4A12120H	测试日期	2025/9/1
测试设备型号	JF-101B锡炉	测试数量	3pcs
测试项目	沾锡性	测试地点	实验室
测试条件	焊接温度: $260 \pm 5^{\circ}\text{C}$ 焊接时间: 4~5 seconds		
测试要求	满足95%的覆盖率		
测试结果	满足95%的覆盖率		
判定	合格		
附图片:	 <p>沾锡试验</p>		
拟制: 王学富	审核: 白明	核准: 田心满	

Test Report



Report No. A2240674117101004

Company Name shown on Report DONGGUAN SKYLINK NEW MATERIAL CO., LTD

Address ROOM 601, VANKE CENTER OFFICE BUILDING, CHANG 'AN TOWN, DONGGUAN CITY

The following sample(s) and sample information was/were submitted and identified by/on the behalf of the applicant

Sample Name LCP
Model No. VE E130I BK210P BLACK A1
Sample Received Date Oct. 31, 2024
Testing Period Oct. 31, 2024 to Nov. 4, 2024

Test Requested As specified by client, to test Lead (Pb), Cadmium (Cd), Mercury (Hg), Hexavalent Chromium (Cr(VI)), Polybrominated Biphenyls (PBBs), Polybrominated Diphenyl Ethers (PBDEs), Phthalates (DBP, BBP, DEHP, DIBP) in the submitted sample(s).

Test Method Please refer to the following page(s).

Test Result(s) Please refer to the following page(s).



Approved by

Anso Fang

Date

Nov. 4, 2024

Anso Fang

Lab Authorized Signatory

No. R393381719

CTI Building, Xing Dong Community, Xin'an Sub-district, Bao'an District, Shenzhen City, Guangdong Province, P.R. China

Test Report

Report No. A2240674117101004

Page 2 of 7

Test Method

Test Item(s)	Test Method	Measured Equipment(s)
Lead (Pb)	IEC 62321-5:2013	ICP-OES
Cadmium (Cd)	IEC 62321-5:2013	ICP-OES
Mercury (Hg)	IEC 62321-4:2013+AMD1:2017 CSV	ICP-OES
Hexavalent Chromium (Cr(VI))	IEC 62321-7-2:2017 and/or determination of Total Chromium by IEC 62321-5:2013	UV-Vis/ICP-OES
Polybrominated Biphenyls (PBBs)	IEC 62321-6:2015	GC-MS
Polybrominated Diphenyl Ethers (PBDEs)	IEC 62321-6:2015	GC-MS
Phthalates (DBP, BBP, DEHP, DIBP)	IEC 62321-8:2017	GC-MS

Test Report

Report No. A2240674117101004

Page 3 of 7

Test Result(s)

Tested Item(s)	Result	MDL
	004	
Lead (Pb)	N.D.	2 mg/kg
Cadmium (Cd)	N.D.	2 mg/kg
Mercury (Hg)	N.D.	2 mg/kg
Hexavalent Chromium (Cr(VI))	N.D.	8 mg/kg
Tested Item(s)	Result	MDL
	004	
Polybrominated Biphenyls (PBBs)		
Monobromobiphenyl	N.D.	5 mg/kg
Dibromobiphenyl	N.D.	5 mg/kg
Tribromobiphenyl	N.D.	5 mg/kg
Tetrabromobiphenyl	N.D.	5 mg/kg
Pentabromobiphenyl	N.D.	5 mg/kg
Hexabromobiphenyl	N.D.	5 mg/kg
Heptabromobiphenyl	N.D.	5 mg/kg
Octabromobiphenyl	N.D.	5 mg/kg
Nonabromobiphenyl	N.D.	5 mg/kg
Decabromobiphenyl	N.D.	5 mg/kg
Tested Item(s)	Result	MDL
	004	
Polybrominated Diphenyl Ethers (PBDEs)		
Monobromodiphenyl ether	N.D.	5 mg/kg
Dibromodiphenyl ether	N.D.	5 mg/kg
Tribromodiphenyl ether	N.D.	5 mg/kg
Tetrabromodiphenyl ether	N.D.	5 mg/kg
Pentabromodiphenyl ether	N.D.	5 mg/kg
Hexabromodiphenyl ether	N.D.	5 mg/kg
Heptabromodiphenyl ether	N.D.	5 mg/kg
Octabromodiphenyl ether	N.D.	5 mg/kg
Nonabromodiphenyl ether	N.D.	5 mg/kg
Decabromodiphenyl ether	N.D.	5 mg/kg

Test Report

Report No. A2240674117101004

Page 4 of 7

Test Result(s)

Tested Item(s)	Result	MDL
	004	
Phthalates (DBP, BBP, DEHP, DIBP)		
Dibutyl phthalate (DBP) CAS#:84-74-2	N.D.	50 mg/kg
Butyl benzyl phthalate (BBP) CAS#:85-68-7	N.D.	50 mg/kg
Di-(2-ethylhexyl) phthalate (DEHP) CAS#:117-81-7	N.D.	50 mg/kg
Diisobutyl phthalate (DIBP) CAS#:84-69-5	N.D.	50 mg/kg

Sample/Part Description

No.	CTI Sample ID	Description
1	004	Black plastic grains

Remark: The sample(s) had been dissolved totally tested for Lead, Cadmium, Mercury.

-MDL = Method Detection Limit

-N.D. = Not Detected (<MDL)

-mg/kg = ppm = parts per million

Test Report

Report No. A2240674117101004

Page 5 of 7

Test Process

1. Lead (Pb), Cadmium (Cd), Chromium (Cr)

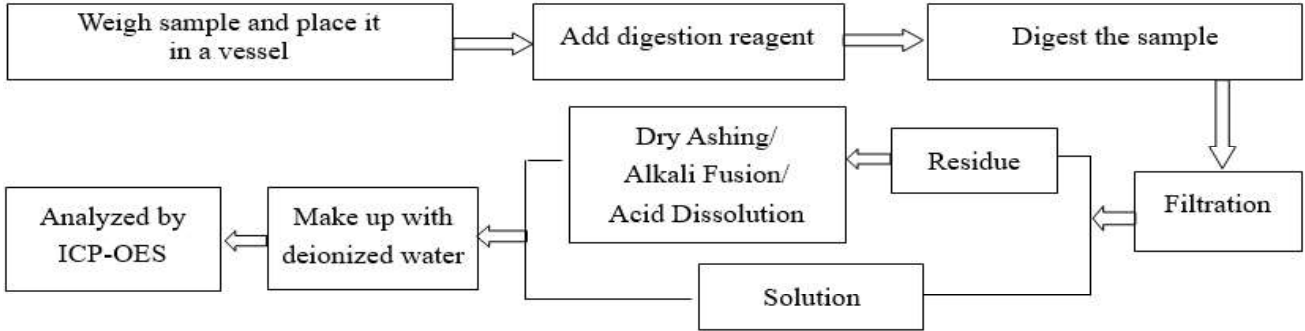

2. Mercury (Hg)

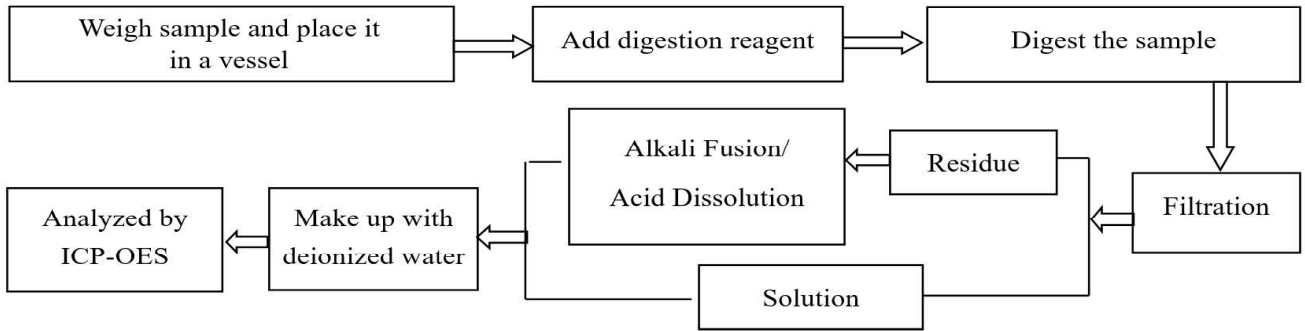

3. Hexavalent Chromium (Cr(VI))

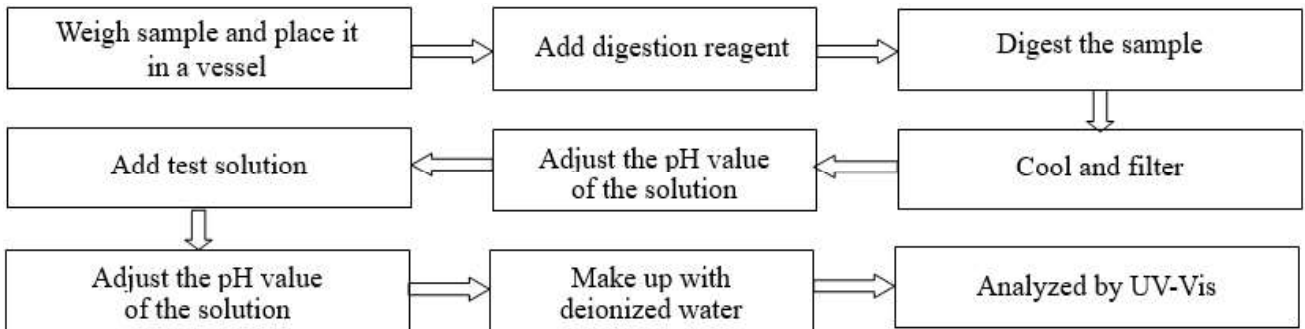

4. Polybrominated Biphenyls (PBBs), Polybrominated Diphenyl Ethers (PBDEs)

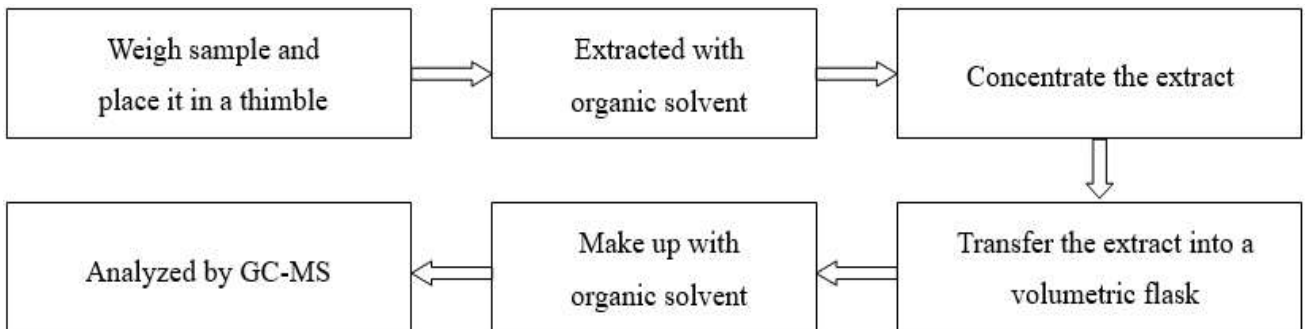

Test Report

Report No. A2240674117101004

Page 6 of 7

5. Phthalates (DBP, BBP, DEHP, DIBP)

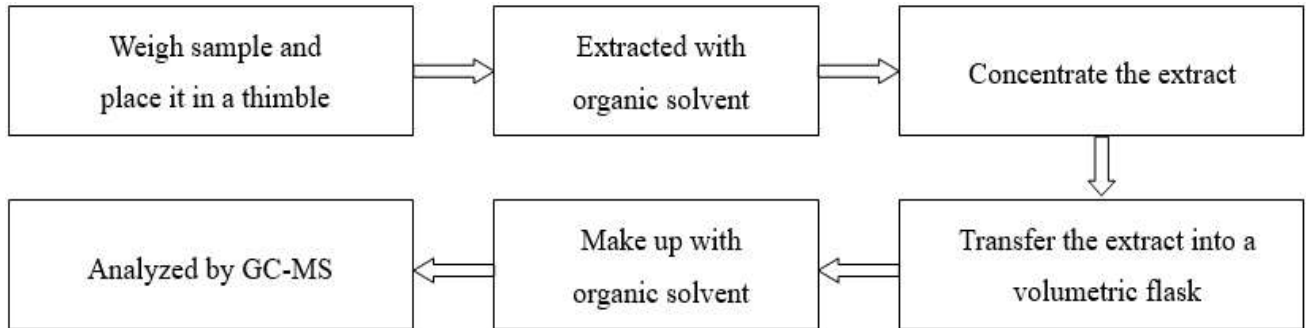

华测检测有限公司

Test Report

Report No. A2240674117101004

Page 7 of 7

Photo(s) of the sample(s)



Statement:

1. This report is considered invalid without approved signature, special seal and the seal on the perforation;
2. The Company Name shown on Report and Address, the sample(s) and sample information was/were provided by the applicant who should be responsible for the authenticity which CTI hasn't verified;
3. The result(s) shown in this report refer(s) only to the sample(s) tested;
4. Unless otherwise stated, the decision rule for conformity reporting is based on Binary Statement for Simple Acceptance Rule (w=0) stated in ILAC-G8:09/2019 / CNAS-GL015:2022;
5. Without written approval of CTI, this report can't be reproduced except in full;
6. In case of any discrepancy between the English version and Chinese version of the testing reports (if generated), the Chinese version shall prevail.

*** End of report ***

检测报告

编号: CANEC24029754106_1

日期: 2025 年 01 月 07 日

第 1 页, 共 7 页

客户名称: 清远楚江高精铜带有限公司
客户地址: 广东省清远市清城区高新技术产业开发区创兴二路 15 号

样品名称: H65 (C2680)

以上样品及信息由客户提供。

此报告替代原来编号为 CANEC24029754106, 日期为 2025 年 01 月 06 日的报告。

SGS 工作编号: GZP24-041477
样品接收时间: 2024 年 12 月 30 日
检测周期: 2024 年 12 月 30 日 ~ 2025 年 01 月 06 日
检测要求: 根据客户要求检测
检测方法: 见后续页。
检测结果: 见后续页。

检测要求	结论
欧盟 RoHS 指令 2011/65/EU 附录 II 的修正指令(EU) 2015/863-铅、汞、镉、六价铬、多溴联苯 (PBB)、多溴二苯醚 (PBDE)、邻苯二甲酸二(2-乙基己基)酯 (DEHP)、邻苯二甲酸丁苄酯 (BBP)、邻苯二甲酸二丁酯 (DBP)和邻苯二甲酸二异丁酯 (DIBP)	符合

通标标准技术服务有限公司广州分公司
授权签名

陈江梨

Allie Chen 陈江梨
批准签署人

scan to see the report



EF3C47CE



SGS-CSTC Standards Technical Services Co., Ltd.
Guangzhou Branch Technical Services Laboratory

Unless otherwise agreed in writing, this document is issued by the Company subject to its General Conditions of Service printed overleaf, available on request or accessible at <https://www.sgs.com/en/Terms-and-Conditions>. Attention is drawn to the limitation of liability, indemnification and jurisdiction issues defined therein. Any holder of this document is advised that information contained hereon reflects the Company's findings at the time of its intervention only and within the limits of Client's instructions, if any. The Company's sole responsibility is to its Client and this document does not exonerate parties to a transaction from exercising all their rights and obligations under the transaction documents. This document cannot be reproduced except in full, without prior written approval of the Company. Any unauthorized alteration, forgery or falsification of the content or appearance of this document is unlawful and offenders may be prosecuted to the fullest extent of the law. Unless otherwise stated the results shown in this test report refer only to the sample(s) tested.
Attention: To check the authenticity of testing /inspection report & certificate, please contact us at telephone: (86-755) 8307 1443, or email: CN.Doccheck@sgs.com

No.198, Kezhu Road, Science City, Economic & Technological Development Area, Guangzhou, Guangdong, China 510663
中国·广东·广州高新技术产业开发区科学城科珠路198号 邮编: 510663

t (86-20) 82155555 www.sgs.com.cn
t (86-20) 82155555 sgs.china@sgs.com

检测结果:

检测部件外观描述:

样品序号	样品编号	SGS 样品 ID	样品描述
SN1	A2	CAN24-0297541-0001.C002	黄铜色金属板

备注:

- (1) 1 mg/kg = 1 ppm = 0.0001%
- (2) MDL= 方法检出限
- (3) ND = 未检出(< MDL)
- (4) "-" = 未规定

欧盟 RoHS 指令 2011/65/EU 附录 II 的修正指令(EU) 2015/863-铅、汞、镉、六价铬、多溴联苯 (PBB)、多溴二苯醚 (PBDE)、邻苯二甲酸二(2-乙基己基)酯 (DEHP)、邻苯二甲酸丁苄酯 (BBP)、邻苯二甲酸二丁酯 (DBP)和邻苯二甲酸二异丁酯 (DIBP)

检测方法: 参考 IEC 62321-4:2013+AMD1:2017, IEC 62321-5:2013, IEC 62321-7-1:2015 和 IEC 62321-12:2023, 采用 ICP-OES/AAS, UV-Vis 和 GC-MS 进行分析。

检测项目	限值	单位	MDL	A2
铅 (Pb)	1000	mg/kg	2	16
汞 (Hg)	1000	mg/kg	2	ND
镉 (Cd)	100	mg/kg	2	ND
六价铬 (Cr(VI))▼	-	µg/cm ²	0.10	ND
多溴联苯之和 (PBB)	1000	mg/kg	-	ND
一溴联苯 (MonoBB)	-	mg/kg	25	ND
二溴联苯 (DiBB)	-	mg/kg	25	ND
三溴联苯 (TriBB)	-	mg/kg	25	ND
四溴联苯 (TetraBB)	-	mg/kg	25	ND
五溴联苯 (PentaBB)	-	mg/kg	25	ND
六溴联苯 (HexaBB)	-	mg/kg	25	ND
七溴联苯 (HeptaBB)	-	mg/kg	25	ND
八溴联苯 (OctaBB)	-	mg/kg	25	ND
九溴联苯 (NonaBB)	-	mg/kg	25	ND
十溴联苯 (DecaBB)	-	mg/kg	25	ND
多溴二苯醚之和 (PBDE)	1000	mg/kg	-	ND
一溴二苯醚 (MonoBDE)	-	mg/kg	25	ND
二溴二苯醚 (DiBDE)	-	mg/kg	25	ND
三溴二苯醚 (TriBDE)	-	mg/kg	25	ND
四溴二苯醚 (TetraBDE)	-	mg/kg	25	ND
五溴二苯醚 (PentaBDE)	-	mg/kg	25	ND
六溴二苯醚 (HexaBDE)	-	mg/kg	25	ND
七溴二苯醚 (HeptaBDE)	-	mg/kg	25	ND
八溴二苯醚 (OctaBDE)	-	mg/kg	25	ND



Unless otherwise agreed in writing, this document is issued by the Company subject to its General Conditions of Service printed overleaf, available on request or accessible at <https://www.sgs.com/en/Terms-and-Conditions>. Attention is drawn to the limitation of liability, indemnification and jurisdiction issues defined therein. Any holder of this document is advised that information contained hereon reflects the Company's findings at the time of its intervention only and within the limits of Client's instructions, if any. The Company's sole responsibility is to its Client and this document does not exonerate parties to a transaction from exercising all their rights and obligations under the transaction documents. This document cannot be reproduced except in full, without prior written approval of the Company. Any unauthorized alteration, forgery or falsification of the content or appearance of this document is unlawful and offenders may be prosecuted to the fullest extent of the law. Unless otherwise stated the results shown in this test report refer only to the sample(s) tested.
Attention: To check the authenticity of testing / inspection report & certificate, please contact us at telephone: (86-755) 8307 1443, or email: CN.Doccheck@sgs.com

检测报告

编号: CANEC24029754106_1

日期: 2025年01月07日

第3页, 共7页

检测项目	限值	单位	MDL	A2
九溴二苯醚 (NonaBDE)	-	mg/kg	25	ND
十溴二苯醚 (DecaBDE)	-	mg/kg	25	ND
邻苯二甲酸二(2-乙基己基)酯 (DEHP)	1000	mg/kg	50	ND
邻苯二甲酸丁苄酯 (BBP)	1000	mg/kg	50	ND
邻苯二甲酸二丁酯 (DBP)	1000	mg/kg	50	ND
邻苯二甲酸二异丁酯 (DIBP)	1000	mg/kg	50	ND

备注:

- (1) 最大允许限值引用自RoHS指令(EU) 2015/863。
- (2) IEC 62321系列等同于 EN 62321系列。
- (3) ▼ =
 - a. 当六价铬的浓度高于0.13 µg/cm²时, 样品为阳性, 即含有六价铬;
 - b. 当六价铬的浓度为ND (低于0.10 µg/cm²) 时, 样品为阴性, 即未检测到六价铬;
 - c. 当六价铬的浓度介于0.10 µg/cm²与0.13 µg/cm²之间时, 无法直接判定是否检测到六价铬, 因不同个体的样品表面差异可能会影响测定结果。

由于未获知样品的存储条件和生产日期, 样品的六价铬检测结果仅能代表检测时样品含六价铬的状态。

本报告更新了样品名称。

除非另有说明, 参照 ILAC-G8:09/2019, 使用简单接受 (w=0) 的二元判定规则进行符合性判定。

除非另有说明, 此报告结果仅对检测的样品负责。本报告未经本公司书面许可, 不可部分复制。

检测报告仅用于客户科研、教学、内部质量控制、产品研发等目的, 仅供内部参考。



Unless otherwise agreed in writing, this document is issued by the Company subject to its General Conditions of Service printed overleaf, available on request or accessible at <https://www.sgs.com/en/Terms-and-Conditions>. Attention is drawn to the limitation of liability, indemnification and jurisdiction issues defined therein. Any holder of this document is advised that information contained hereon reflects the Company's findings at the time of its intervention only and within the limits of Client's instructions, if any. The Company's sole responsibility is to its Client and this document does not exonerate parties to a transaction from exercising all their rights and obligations under the transaction documents. This document cannot be reproduced except in full, without prior written approval of the Company. Any unauthorized alteration, forgery or falsification of the content or appearance of this document is unlawful and offenders may be prosecuted to the fullest extent of the law. Unless otherwise stated the results shown in this test report refer only to the sample(s) tested.
 Attention: To check the authenticity of testing /inspection report & certificate, please contact us at telephone: (86-755) 8307 1443, or email: CN.Doccheck@sgs.com

附件

元素检测流程图

样品按照下述流程被完全消解

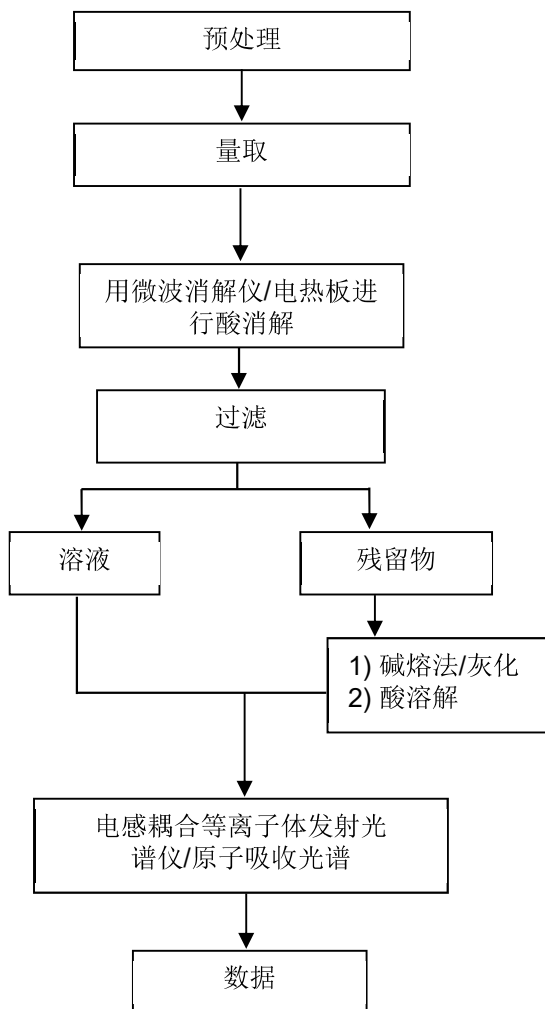

六价铬检测流程图

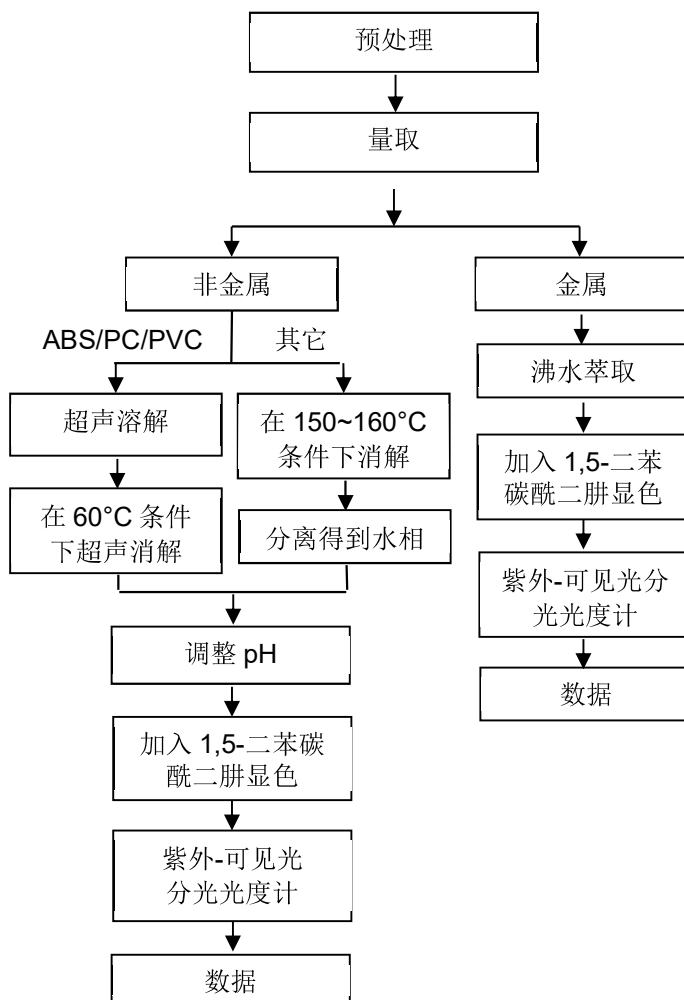

PBB/PBDE/Phthalates 检测流程图

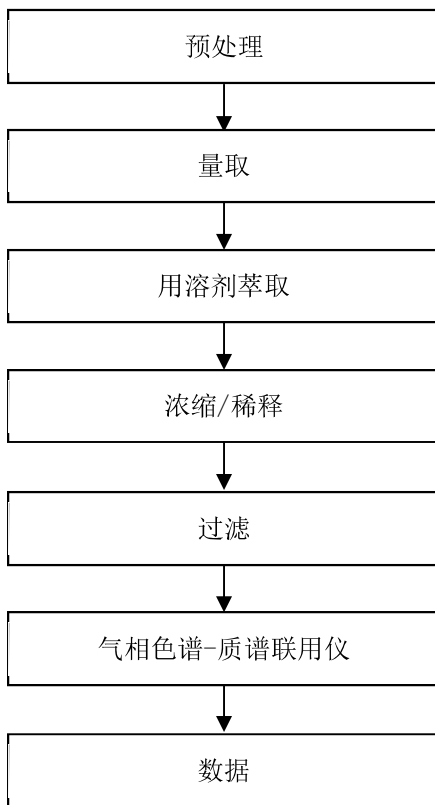

检测报告

编号: CANEC24029754106_1

日期: 2025年01月07日

第7页, 共7页

样品照片:

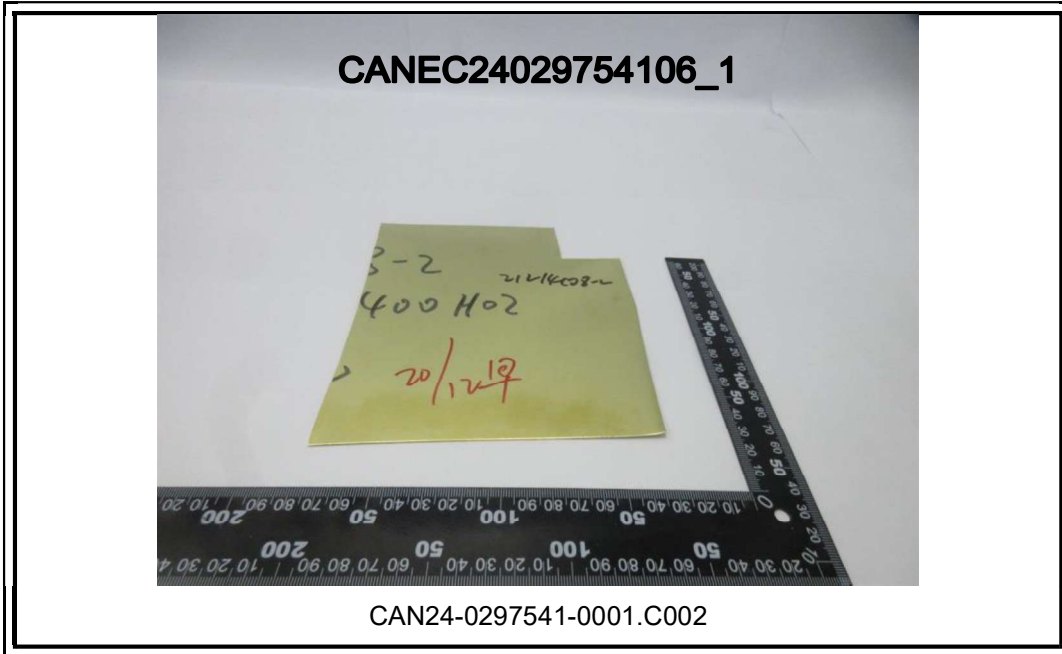

此照片仅限于随 SGS 正本报告使用
报告结束



SGS-CT Standards Technical Services Co., Ltd.
Guangzhou Branch Technical Services Co., Ltd. Technical Laboratory

Unless otherwise agreed in writing, this document is issued by the Company subject to its General Conditions of Service printed overleaf, available on request or accessible at <https://www.sgs.com/en/Terms-and-Conditions>. Attention is drawn to the limitation of liability, indemnification and jurisdiction issues defined therein. Any holder of this document is advised that information contained hereon reflects the Company's findings at the time of its intervention only and within the limits of Client's instructions, if any. The Company's sole responsibility is to its Client and this document does not exonerate parties to a transaction from exercising all their rights and obligations under the transaction documents. This document cannot be reproduced except in full, without prior written approval of the Company. Any unauthorized alteration, forgery or falsification of the content or appearance of this document is unlawful and offenders may be prosecuted to the fullest extent of the law. Unless otherwise stated the results shown in this test report refer only to the sample(s) tested.
Attention: To check the authenticity of testing / inspection report & certificate, please contact us at telephone: (86-755) 8307 1443, or email: CN.Doccheck@sgs.com

No.198, Kezhu Road, Science City, Economic & Technological Development Area, Guangzhou, Guangdong, China 510663
中国·广东·广州高新技术产业开发区科学城科珠路198号 邮编: 510663

t (86-20) 82155555 www.sgsgroup.com.cn
t (86-20) 82155555 sgs.china@sgs.com

检测报告

编号: SZXEC24003572608

日期: 2024 年 11 月 20 日

第 1 页, 共 7 页

客户名称: 圣刚表面处理(深圳)有限公司
客户地址: 深圳市宝安区松岗镇江边工业区创业三路

样品名称: 镍
主要成分: 材质: 黄铜; 镀层: 镍
以上样品及信息由客户提供。

SGS 工作编号: SZP24-050135
样品接收时间: 2024 年 11 月 14 日
检测周期: 2024 年 11 月 14 日 ~ 2024 年 11 月 20 日
检测要求: 根据客户要求检测
检测方法: 见后续页。
检测结果: 见后续页。

检测要求	结论
欧盟 RoHS 指令 2011/65/EU 附录 II 的修正指令(EU) 2015/863-铅、汞、镉、六价铬、多溴联苯 (PBB)、多溴二苯醚 (PBDE)、邻苯二甲酸二(2-乙基己基)酯 (DEHP)、邻苯二甲酸丁苄酯 (BBP)、邻苯二甲酸二丁酯 (DBP)和邻苯二甲酸二异丁酯 (DIBP)	符合

通标标准技术服务有限公司深圳分公司
授权签名

袁依婷

Fay Yuan 袁依婷
批准签署人

scan to see the report



5647A0F4



SGS-CSTC 通标标准技术服务有限公司深圳分公司
Shenzhen Branch Testing Center Chemical Laboratory

Unless otherwise agreed in writing, this document is issued by the Company subject to its General Conditions of Service printed overleaf, available on request or accessible at <http://www.sgs.com/en/Terms-and-Conditions.aspx> and, for electronic format documents, subject to Terms and Conditions for Electronic Documents at <http://www.sgs.com/en/Terms-and-Conditions/Terms-e-Documents.aspx>. Attention is drawn to the limitation of liability, indemnification and jurisdiction issues defined therein. Any holder of this document is advised that information contained hereon reflects the Company's findings at the time of its intervention only and within the limits of Client's instructions, if any. The Company's sole responsibility is to its Client and this document does not exonerate parties to a transaction from exercising all their rights and obligations under the transaction documents. This document cannot be reproduced except in full, without prior written approval of the Company. Any unauthorized alteration, forgery or falsification of the content or appearance of this document is unlawful and offenders may be prosecuted to the fullest extent of the law. Unless otherwise stated the results shown in this test report refer only to the sample(s) tested.

Attention: To check the authenticity of testing / inspection report & certificate, please contact us at telephone: (86-755) 8307 1443, or email: CN.Doccheck@sgs.com

Room 101-901, Plant 4 & Room 101, Plant 2 & Room 101, Plant 3 & Room 301-501, Plant 3, Jianghao (Bantian) Industrial Plant Area, No. 430, Jihua Road, Bantian Community, Bantian Street, Longgang District, Shenzhen, Guangdong, China 518129 www.sgs.com
中国·广东·深圳市龙岗区坂田街道坂田社区吉华路430号江豪(坂田)工业厂区厂房4号101-901、2号101、3号101、3号301-501 邮编:518129 t:(86-755) 25328888 sgs.china@sgs.com

检测报告

编号: SZXEC24003572608

日期: 2024 年 11 月 20 日

第 2 页, 共 7 页

检测结果:

检测部件外观描述:

样品序号	样品编号	SGS 样品 ID	样品描述
SN1	A2	SZX24-0035726-0001.C002	带银色镀层的金属

备注:

- (1) 1 mg/kg = 1 ppm = 0.0001%
- (2) MDL= 方法检出限
- (3) ND = 未检出 (< MDL)
- (4) "-" = 未规定

欧盟 RoHS 指令 2011/65/EU 附录 II 的修正指令(EU) 2015/863-铅、汞、镉、六价铬、多溴联苯 (PBB)、多溴二苯醚 (PBDE)、邻苯二甲酸二(2-乙基己基)酯 (DEHP)、邻苯二甲酸丁苄酯 (BBP)、邻苯二甲酸二丁酯 (DBP)和邻苯二甲酸二异丁酯 (DIBP)

检测方法: 参考 IEC 62321-4:2013+AMD1:2017, IEC 62321-5:2013, IEC 62321-7-1:2015 和 IEC 62321-12:2023, 采用 ICP-OES/AAS, UV-Vis 和 GC-MS 进行分析。

检测项目	限值	单位	MDL	A2
铅 (Pb)	1000	mg/kg	2	64
汞 (Hg)	1000	mg/kg	2	ND
镉 (Cd)	100	mg/kg	2	ND
六价铬 (Cr(VI))▼	-	µg/cm ²	0.10	ND
多溴联苯之和 (PBB)	1000	mg/kg	-	ND
一溴联苯 (MonoBB)	-	mg/kg	25	ND
二溴联苯 (DiBB)	-	mg/kg	25	ND
三溴联苯 (TriBB)	-	mg/kg	25	ND
四溴联苯 (TetraBB)	-	mg/kg	25	ND
五溴联苯 (PentaBB)	-	mg/kg	25	ND
六溴联苯 (HexaBB)	-	mg/kg	25	ND
七溴联苯 (HeptaBB)	-	mg/kg	25	ND
八溴联苯 (OctaBB)	-	mg/kg	25	ND
九溴联苯 (NonaBB)	-	mg/kg	25	ND
十溴联苯 (DecaBB)	-	mg/kg	25	ND
多溴二苯醚之和 (PBDE)	1000	mg/kg	-	ND
一溴二苯醚 (MonoBDE)	-	mg/kg	25	ND
二溴二苯醚 (DiBDE)	-	mg/kg	25	ND
三溴二苯醚 (TriBDE)	-	mg/kg	25	ND
四溴二苯醚 (TetraBDE)	-	mg/kg	25	ND
五溴二苯醚 (PentaBDE)	-	mg/kg	25	ND
六溴二苯醚 (HexaBDE)	-	mg/kg	25	ND
七溴二苯醚 (HeptaBDE)	-	mg/kg	25	ND
八溴二苯醚 (OctaBDE)	-	mg/kg	25	ND



SGS-CSTC Standards Technical Services Co., Ltd.
Shenzhen Branch Testing Center-Chemical Laboratory

Unless otherwise agreed in writing, this document is issued by the Company subject to its General Conditions of Service printed overleaf, available on request or accessible at <http://www.sgs.com/en/Terms-and-Conditions.aspx> and, for electronic format documents, subject to Terms and Conditions for Electronic Documents at <http://www.sgs.com/en/Terms-and-Conditions/Terms-e-Documents.aspx>. Attention is drawn to the limitation of liability, indemnification and jurisdiction issues defined therein. Any holder of this document is advised that information contained hereon reflects the Company's findings at the time of its intervention only and within the limits of Client's instructions, if any. The Company's sole responsibility is to its Client and this document does not exonerate parties to a transaction from exercising all their rights and obligations under the transaction documents. This document cannot be reproduced except in full, without prior written approval of the Company. Any unauthorized alteration, forgery or falsification of the content or appearance of this document is unlawful and offenders may be prosecuted to the fullest extent of the law. Unless otherwise stated the results shown in this test report refer only to the sample(s) tested.

Attention: To check the authenticity of testing /inspection report & certificate, please contact us at telephone: (86-755) 8307 1443, or email: CN.Doccheck@sgs.com

Room 101-901, Plant 4 & Room 101, Plant 2 & Room 101, Plant 3 & Room 301-501, Plant 3, Jiangqiao (Bantian) Industrial Plant Area, No. 430, Jihua Road, Bantian Community, Bantian Street, Longgang District, Shenzhen, Guangdong, China 518129 www.sgs.com.cn
中国·广东·深圳市龙岗区坂田街道坂田社区吉华路430号江桥(坂田)工业区厂房4号101-901、2号101、3号101、3号301-501 邮编:518129 t:(86-755) 25328888 sgs.china@sgs.com

检测项目	限值	单位	MDL	A2
九溴二苯醚 (NonaBDE)	-	mg/kg	25	ND
十溴二苯醚 (DecaBDE)	-	mg/kg	25	ND
邻苯二甲酸二(2-乙基己基)酯 (DEHP)	1000	mg/kg	50	ND
邻苯二甲酸丁苄酯 (BBP)	1000	mg/kg	50	ND
邻苯二甲酸二丁酯 (DBP)	1000	mg/kg	50	ND
邻苯二甲酸二异丁酯 (DIBP)	1000	mg/kg	50	ND

备注:

- (1) 最大允许限值引用自RoHS指令(EU) 2015/863。
- (2) IEC 62321系列等同于 EN 62321系列。
- (3) ▼ =
 - a. 当六价铬的浓度高于0.13 µg/cm²时, 样品为阳性, 即含有六价铬;
 - b. 当六价铬的浓度为ND (低于0.10 µg/cm²) 时, 样品为阴性, 即未检测到六价铬;
 - c. 当六价铬的浓度介于0.10 µg/cm²与0.13 µg/cm²之间时, 无法直接判定是否检测到六价铬, 因不同个体的样品表面差异可能会影响测定结果。

由于未获知样品的存储条件和生产日期, 样品的六价铬检测结果仅能代表检测时样品含六价铬的状态。

除非另有说明, 参照 ILAC-G8:09/2019, 使用简单接受 (w=0) 的二元判定规则进行符合性判定。
 除非另有说明, 此报告结果仅对检测的样品负责。本报告未经本公司书面许可, 不可部分复制。
 检测报告仅用于客户科研、教学、内部质量控制、产品研发等目的, 仅供内部参考。



Unless otherwise agreed in writing, this document is issued by the Company subject to its General Conditions of Service printed overleaf, available on request or accessible at <http://www.sgs.com/en/Terms-and-Conditions.aspx> and, for electronic format documents, subject to Terms and Conditions for Electronic Documents at <http://www.sgs.com/en/Terms-and-Conditions/Terms-e-Documents.aspx>. Attention is drawn to the limitation of liability, indemnification and jurisdiction issues defined therein. Any holder of this document is advised that information contained hereon reflects the Company's findings at the time of its intervention only and within the limits of Client's instructions, if any. The Company's sole responsibility is to its Client and this document does not exonerate parties to a transaction from exercising all their rights and obligations under the transaction documents. This document cannot be reproduced except in full, without prior written approval of the Company. Any unauthorized alteration, forgery or falsification of the content or appearance of this document is unlawful and offenders may be prosecuted to the fullest extent of the law. Unless otherwise stated the results shown in this test report refer only to the sample(s) tested.

Attention: To check the authenticity of testing /inspection report & certificate, please contact us at telephone: (86-755) 8307 1443, or email: CN.Doccheck@sgs.com

Room 101-901, Plant 4 & Room 101, Plant 2 & Room 101, Plant 3 & Room 301-501, Plant 3, Jianghao (Bantian) Industrial Plant Area, No. 430, Jihua Road, Bantian Community, Bantian Street, Longgang District, Shenzhen, Guangdong, China 518129 www.sgs.com.cn
 中国·广东·深圳市龙岗区坂田街道坂田社区吉华路430号江灏(坂田)工业厂区厂房4号101-901、2号101、3号101、3号301-501 邮编:518129 t:(86-755) 25328888 sgs.china@sgs.com

附件

元素检测流程图

样品按照下述流程被完全消解

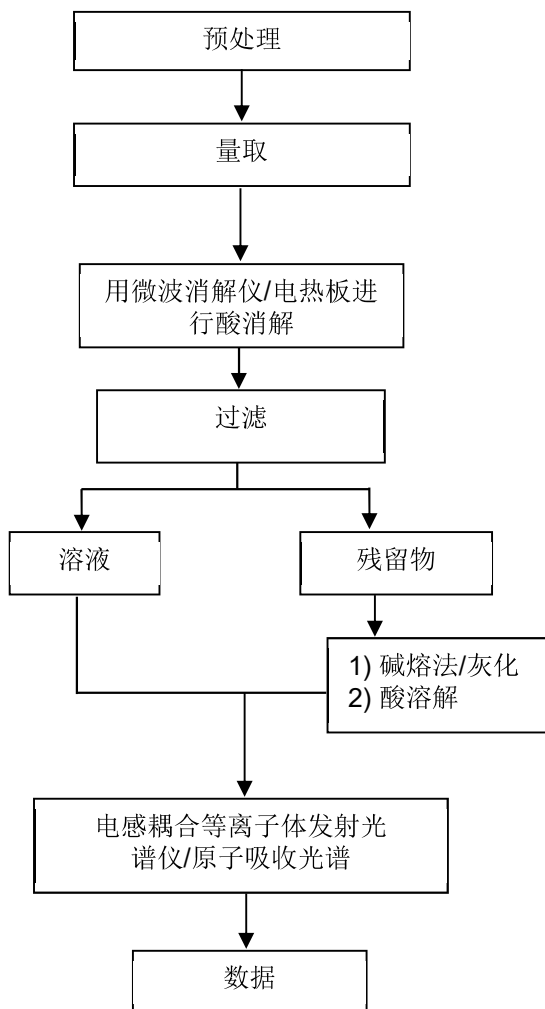

SGS-CTC Standards Technical Services Co., Ltd.
Shenzhen Branch Testing Center Chemical Laboratory

Unless otherwise agreed in writing, this document is issued by the Company subject to its General Conditions of Service printed overleaf, available on request or accessible at <http://www.sgs.com/en/Terms-and-Conditions.aspx> and, for electronic format documents, subject to Terms and Conditions for Electronic Documents at <http://www.sgs.com/en/Terms-and-Conditions/Terms-e-Documents.aspx>. Attention is drawn to the limitation of liability, indemnification and jurisdiction issues defined therein. Any holder of this document is advised that information contained hereon reflects the Company's findings at the time of its intervention only and within the limits of Client's instructions, if any. The Company's sole responsibility is to its Client and this document does not exonerate parties to a transaction from exercising all their rights and obligations under the transaction documents. This document cannot be reproduced except in full, without prior written approval of the Company. Any unauthorized alteration, forgery or falsification of the content or appearance of this document is unlawful and offenders may be prosecuted to the fullest extent of the law. Unless otherwise stated the results shown in this test report refer only to the sample(s) tested.

Attention: To check the authenticity of testing /inspection report & certificate, please contact us at telephone: (86-755) 8307 1443, or email: CN.Doccheck@sgs.com

Room 101-901, Plant 4 & Room 101, Plant 2 & Room 101, Plant 3 & Room 301-501, Plant 3, Jianghao (Banlan) Industrial Plant Area, No. 430, Jihua Road, Banlan Community, Banlan Street, Longgang District, Shenzhen, Guangdong, China 518129 www.sgs.com
中国·广东·深圳市龙岗区坂田街道坂田社区吉华路430号江灏(坂田)工业区厂房4号101-901、2号101、3号301-501 邮编:518129 t:(86-755) 25328888 sgs.china@sgs.com

六价铬检测流程图

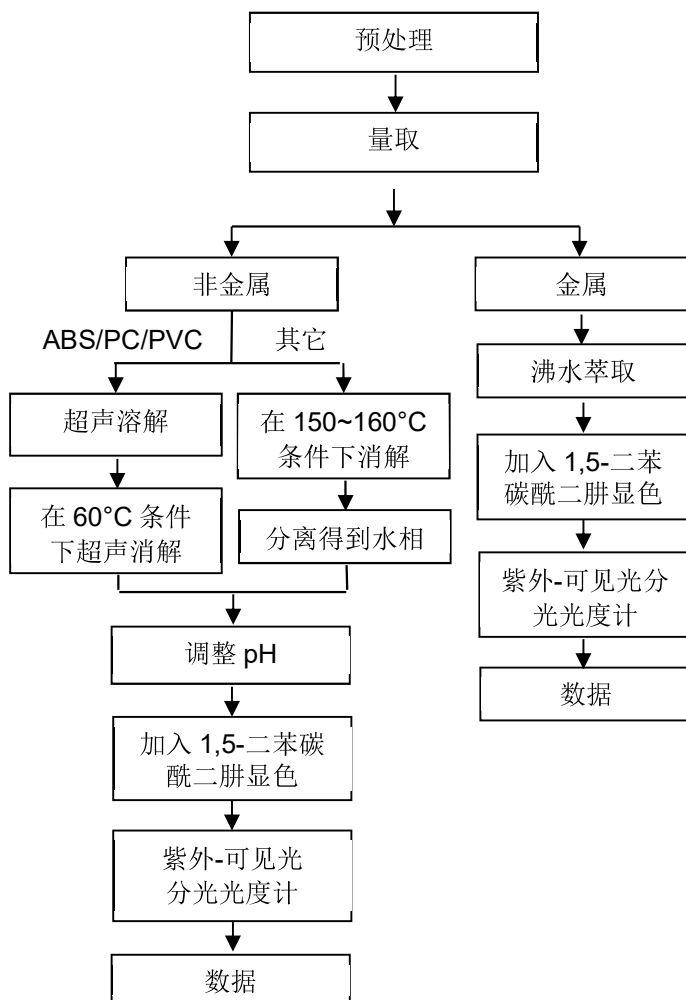

SGS-CTS Standards Technical Services Co., Ltd.
Shenzhen Branch Testing Center-Chemical Laboratory

Unless otherwise agreed in writing, this document is issued by the Company subject to its General Conditions of Service printed overleaf, available on request or accessible at <http://www.sgs.com/en/Terms-and-Conditions.aspx> and, for electronic format documents, subject to Terms and Conditions for Electronic Documents at <http://www.sgs.com/en/Terms-and-Conditions/Terms-e-Documents.aspx>. Attention is drawn to the limitation of liability, indemnification and jurisdiction issues defined therein. Any holder of this document is advised that information contained hereon reflects the Company's findings at the time of its intervention only and within the limits of Client's instructions, if any. The Company's sole responsibility is to its Client and this document does not exonerate parties to a transaction from exercising all their rights and obligations under the transaction documents. This document cannot be reproduced except in full, without prior written approval of the Company. Any unauthorized alteration, forgery or falsification of the content or appearance of this document is unlawful and offenders may be prosecuted to the fullest extent of the law. Unless otherwise stated the results shown in this test report refer only to the sample(s) tested.

Attention: To check the authenticity of testing /inspection report & certificate, please contact us at telephone: (86-755) 8307 1443, or email: CN.Doccheck@sgs.com

Room 101-901, Plant 4 & Room 101, Plant 2 & Room 101, Plant 3 & Room 301-501, Plant 3, Jianghao (Banlan) Industrial Plant Area, No. 430, Jihua Road, Banlan Community, Banlan Street, Longgang District, Shenzhen, Guangdong, China 518129 www.sgs.com
中国·广东·深圳市龙岗区坂田街道坂田社区吉华路430号江灏(坂田)工业厂区厂房4号101-901、2号101、3号101、3号301-501 邮编:518129 t:(86-755) 25328888 sgs.china@sgs.com

PBB/PBDE/Phthalates 检测流程图

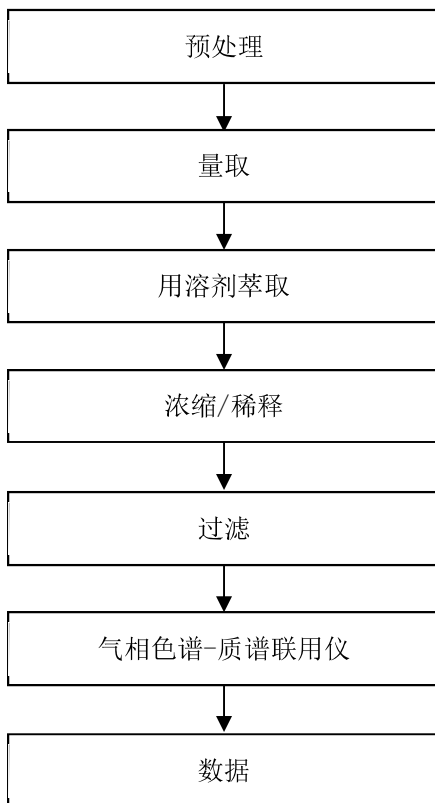

Unless otherwise agreed in writing, this document is issued by the Company subject to its General Conditions of Service printed overleaf, available on request or accessible at <http://www.sgs.com/en/Terms-and-Conditions.aspx> and, for electronic format documents, subject to Terms and Conditions for Electronic Documents at <http://www.sgs.com/en/Terms-and-Conditions/Terms-e-Documents.aspx>. Attention is drawn to the limitation of liability, indemnification and jurisdiction issues defined therein. Any holder of this document is advised that information contained hereon reflects the Company's findings at the time of its intervention only and within the limits of Client's instructions, if any. The Company's sole responsibility is to its Client and this document does not exonerate parties to a transaction from exercising all their rights and obligations under the transaction documents. This document cannot be reproduced except in full, without prior written approval of the Company. Any unauthorized alteration, forgery or falsification of the content or appearance of this document is unlawful and offenders may be prosecuted to the fullest extent of the law. Unless otherwise stated the results shown in this test report refer only to the sample(s) tested.

Attention: To check the authenticity of testing /inspection report & certificate, please contact us at telephone: (86-755) 8307 1443, or email: CN.Doccheck@sgs.com

SGS-CSTC Standards Technical Services Co., Ltd.
Shenzhen Branch Testing Center Chemical Laboratory

Room 101-901, Plant 4 & Room 101, Plant 2 & Room 101, Plant 3 & Room 301-501, Plant 3, Jianghao (Banlian) Industrial Plant Area, No. 430, Jihua Road, Banlian Community, Banlian Street, Longgang District, Shenzhen, Guangdong, China 518129 www.sgs.com.cn
中国·广东·深圳市龙岗区坂田街道坂田社区吉华路430号江灏(坂田)工业区厂房4号101-901、2号101、3号101-501 邮编:518129 t:(86-755) 25328888 sgs.china@sgs.com

检测报告

编号: SZXEC24003572608

日期: 2024 年 11 月 20 日

第 7 页, 共 7 页

样品照片:

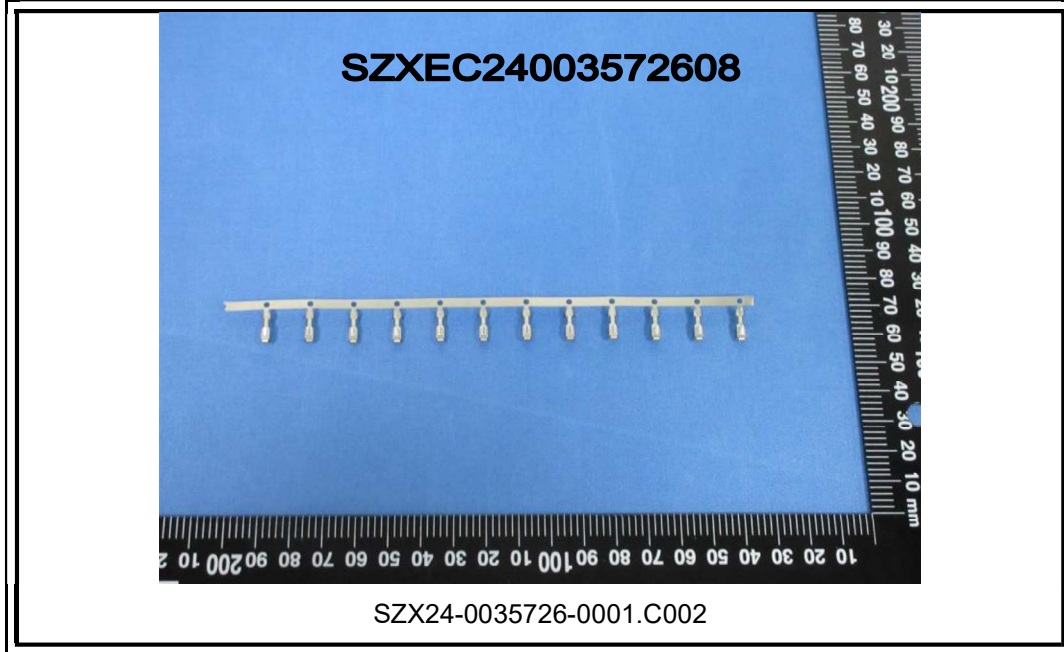

此照片仅限于随 SGS 正本报告使用
报告结束



Unless otherwise agreed in writing, this document is issued by the Company subject to its General Conditions of Service printed overleaf, available on request or accessible at <http://www.sgs.com/en/Terms-and-Conditions.aspx> and, for electronic format documents, subject to Terms and Conditions for Electronic Documents at <http://www.sgs.com/en/Terms-and-Conditions/Terms-e-Documents.aspx>. Attention is drawn to the limitation of liability, indemnification and jurisdiction issues defined therein. Any holder of this document is advised that information contained hereon reflects the Company's findings at the time of its intervention only and within the limits of Client's instructions, if any. The Company's sole responsibility is to its Client and this document does not exonerate parties to a transaction from exercising all their rights and obligations under the transaction documents. This document cannot be reproduced except in full, without prior written approval of the Company. Any unauthorized alteration, forgery or falsification of the content or appearance of this document is unlawful and offenders may be prosecuted to the fullest extent of the law. Unless otherwise stated the results shown in this test report refer only to the sample(s) tested.

Attention: To check the authenticity of testing /inspection report & certificate, please contact us at telephone: (86-755) 8307 1443, or email: CN.Doccheck@sgs.com

SGS-CSTC Standards Technical Services Co., Ltd.
Shenzhen Branch Testing Center-Chemical Laboratory

Room 101-901, Plant 4 & Room 101, Plant 2 & Room 101, Plant 3 & Room 301-501, Plant 3, Jianghao (Bantian) Industrial Plant Area, No. 430, Jihua Road, Bantian Community, Bantian Street, Longgang District, Shenzhen, Guangdong, China 518129 www.sgs.com
中国·广东·深圳市龙岗区坂田街道坂田社区吉华路430号江灏(坂田)工业区厂房4号101-901、2号101、3号301-501 邮编:518129 t:(86-755) 25328888 sgs.china@sgs.com

检测报告

编号: SZXEC24003572612

日期: 2024 年 11 月 20 日

第 1 页, 共 7 页

客户名称: 圣刚表面处理(深圳)有限公司
客户地址: 深圳市宝安区松岗镇江边工业区创业三路

样品名称: 金
主要成分: 材质: 磷铜; 镀层: 金
以上样品及信息由客户提供。

SGS 工作编号: SZP24-050135
样品接收时间: 2024 年 11 月 14 日
检测周期: 2024 年 11 月 14 日 ~ 2024 年 11 月 20 日
检测要求: 根据客户要求检测
检测方法: 见后续页。
检测结果: 见后续页。

检测要求	结论
欧盟 RoHS 指令 2011/65/EU 附录 II 的修正指令(EU) 2015/863-铅、汞、镉、六价铬、多溴联苯(PBB)、多溴二苯醚(PBDE)、邻苯二甲酸二(2-乙基己基)酯(DEHP)、邻苯二甲酸丁苄酯(BBP)、邻苯二甲酸二丁酯(DBP)和邻苯二甲酸二异丁酯(DIBP)	符合

通标标准技术服务有限公司深圳分公司
授权签名

袁依婷

Fay Yuan 袁依婷
批准签署人

scan to see the report



A3EA5E5E

Unless otherwise agreed in writing, this document is issued by the Company subject to its General Conditions of Service printed overleaf, available on request or accessible at <http://www.sgs.com/en/Terms-and-Conditions.aspx> and, for electronic format documents, subject to Terms and Conditions for Electronic Documents at <http://www.sgs.com/en/Terms-and-Conditions/Terms-e-Document.aspx>. Attention is drawn to the limitation of liability, indemnification and jurisdiction issues defined therein. Any holder of this document is advised that information contained hereon reflects the Company's findings at the time of its intervention only and within the limits of Client's instructions, if any. The Company's sole responsibility is to its Client and this document does not exonerate parties to a transaction from exercising all their rights and obligations under the transaction documents. This document cannot be reproduced except in full, without prior written approval of the Company. Any unauthorized alteration, forgery or falsification of the content or appearance of this document is unlawful and offenders may be prosecuted to the fullest extent of the law. Unless otherwise stated the results shown in this test report refer only to the sample(s) tested.

Attention: To check the authenticity of testing / inspection report & certificate, please contact us at telephone: (86-755) 8307 1443, or email: CN.Doccheck@sgs.com

Room 101-901, Plant 4 & Room 101, Plant 2 & Room 101, Plant 3 & Room 301-501, Plant 3, Jianghao (Bantian) Industrial Plant Area, No. 430, Jihua Road, Bantian Community, Bantian Street, Longgang District, Shenzhen, Guangdong, China 518129 www.sgs.com
中国·广东·深圳市龙岗区坂田街道坂田社区吉华路430号江豪(坂田)工业厂区厂房4号101-901、2号101、3号101、3号301-501 邮编:518129 t:(86-755) 25328888 sgs.china@sgs.com



检测报告

编号: SZXEC24003572612

日期: 2024年11月20日

第2页, 共7页

检测结果:

检测部件外观描述:

样品序号	样品编号	SGS 样品 ID	样品描述
SN1	A3	SZX24-0035726-0001.C003	带金色镀层的金属

备注:

- (1) 1 mg/kg = 1 ppm = 0.0001%
- (2) MDL= 方法检出限
- (3) ND = 未检出 (< MDL)
- (4) "-" = 未规定

欧盟 RoHS 指令 2011/65/EU 附录 II 的修正指令(EU) 2015/863-铅、汞、镉、六价铬、多溴联苯 (PBB)、多溴二苯醚 (PBDE)、邻苯二甲酸二(2-乙基己基)酯 (DEHP)、邻苯二甲酸丁苄酯 (BBP)、邻苯二甲酸二丁酯 (DBP)和邻苯二甲酸二异丁酯 (DIBP)

检测方法: 参考 IEC 62321-4:2013+AMD1:2017, IEC 62321-5:2013, IEC 62321-7-1:2015 和 IEC 62321-12:2023, 采用 ICP-OES/AAS, UV-Vis 和 GC-MS 进行分析。

检测项目	限值	单位	MDL	A3
铅 (Pb)	1000	mg/kg	2	8
汞 (Hg)	1000	mg/kg	2	ND
镉 (Cd)	100	mg/kg	2	ND
六价铬 (Cr(VI))▼	-	µg/cm ²	0.10	ND
多溴联苯之和 (PBB)	1000	mg/kg	-	ND
一溴联苯 (MonoBB)	-	mg/kg	25	ND
二溴联苯 (DiBB)	-	mg/kg	25	ND
三溴联苯 (TriBB)	-	mg/kg	25	ND
四溴联苯 (TetraBB)	-	mg/kg	25	ND
五溴联苯 (PentaBB)	-	mg/kg	25	ND
六溴联苯 (HexaBB)	-	mg/kg	25	ND
七溴联苯 (HeptaBB)	-	mg/kg	25	ND
八溴联苯 (OctaBB)	-	mg/kg	25	ND
九溴联苯 (NonaBB)	-	mg/kg	25	ND
十溴联苯 (DecaBB)	-	mg/kg	25	ND
多溴二苯醚之和 (PBDE)	1000	mg/kg	-	ND
一溴二苯醚 (MonoBDE)	-	mg/kg	25	ND
二溴二苯醚 (DiBDE)	-	mg/kg	25	ND
三溴二苯醚 (TriBDE)	-	mg/kg	25	ND
四溴二苯醚 (TetraBDE)	-	mg/kg	25	ND
五溴二苯醚 (PentaBDE)	-	mg/kg	25	ND
六溴二苯醚 (HexaBDE)	-	mg/kg	25	ND
七溴二苯醚 (HeptaBDE)	-	mg/kg	25	ND
八溴二苯醚 (OctaBDE)	-	mg/kg	25	ND



SGS-CSTC Standards Technical Services Co., Ltd.
Shenzhen Branch Testing Center-Chemical Laboratory

Unless otherwise agreed in writing, this document is issued by the Company subject to its General Conditions of Service printed overleaf, available on request or accessible at <http://www.sgs.com/en/Terms-and-Conditions.aspx> and, for electronic format documents, subject to Terms and Conditions for Electronic Documents at <http://www.sgs.com/en/Terms-and-Conditions/Terms-e-Documents.aspx>. Attention is drawn to the limitation of liability, indemnification and jurisdiction issues defined therein. Any holder of this document is advised that information contained hereon reflects the Company's findings at the time of its intervention only and within the limits of Client's instructions, if any. The Company's sole responsibility is to its Client and this document does not exonerate parties to a transaction from exercising all their rights and obligations under the transaction documents. This document cannot be reproduced except in full, without prior written approval of the Company. Any unauthorized alteration, forgery or falsification of the content or appearance of this document is unlawful and offenders may be prosecuted to the fullest extent of the law. Unless otherwise stated the results shown in this test report refer only to the sample(s) tested.

Attention: To check the authenticity of testing /inspection report & certificate, please contact us at telephone: (86-755) 8307 1443, or email: CN.Doccheck@sgs.com

Room 101-901, Plant 4 & Room 101, Plant 2 & Room 101, Plant 3 & Room 301-501, Plant 3, Jiangqiao (Bantian) Industrial Plant Area, No. 430, Jihua Road, Bantian Community, Bantian Street, Longgang District, Shenzhen, Guangdong, China 518129 www.sgs.com.cn
中国·广东·深圳市龙岗区坂田街道坂田社区吉华路430号江桥(坂田)工业区厂房4号101-901、2号101、3号101、3号301-501 邮编:518129 t(86-755) 25328888 sgs.china@sgs.com

检测报告

编号: SZXEC24003572612

日期: 2024年11月20日

第3页, 共7页

检测项目	限值	单位	MDL	A3
九溴二苯醚 (NonaBDE)	-	mg/kg	25	ND
十溴二苯醚 (DecaBDE)	-	mg/kg	25	ND
邻苯二甲酸二(2-乙基己基)酯 (DEHP)	1000	mg/kg	50	ND
邻苯二甲酸丁苄酯 (BBP)	1000	mg/kg	50	ND
邻苯二甲酸二丁酯 (DBP)	1000	mg/kg	50	ND
邻苯二甲酸二异丁酯 (DIBP)	1000	mg/kg	50	ND

备注:

- (1) 最大允许限值引用自RoHS指令(EU) 2015/863。
- (2) IEC 62321系列等同于 EN 62321系列。
- (3) ▼ =
 - a. 当六价铬的浓度高于0.13 µg/cm²时, 样品为阳性, 即含有六价铬;
 - b. 当六价铬的浓度为ND (低于0.10 µg/cm²) 时, 样品为阴性, 即未检测到六价铬;
 - c. 当六价铬的浓度介于0.10 µg/cm²与0.13 µg/cm²之间时, 无法直接判定是否检测到六价铬, 因不同个体的样品表面差异可能会影响测定结果。

由于未获知样品的存储条件和生产日期, 样品的六价铬检测结果仅能代表检测时样品含六价铬的状态。

除非另有说明, 参照 ILAC-G8:09/2019, 使用简单接受 (w=0) 的二元判定规则进行符合性判定。
 除非另有说明, 此报告结果仅对检测的样品负责。本报告未经本公司书面许可, 不可部分复制。
 检测报告仅用于客户科研、教学、内部质量控制、产品研发等目的, 仅供内部参考。



SGS-CSTC Standards Technical Services Co., Ltd.
 Shenzhen Branch Testing Center-Chemical Laboratory

Unless otherwise agreed in writing, this document is issued by the Company subject to its General Conditions of Service printed overleaf, available on request or accessible at <http://www.sgs.com/en/Terms-and-Conditions.aspx> and, for electronic format documents, subject to Terms and Conditions for Electronic Documents at <http://www.sgs.com/en/Terms-and-Conditions/Terms-e-Documents.aspx>. Attention is drawn to the limitation of liability, indemnification and jurisdiction issues defined therein. Any holder of this document is advised that information contained hereon reflects the Company's findings at the time of its intervention only and within the limits of Client's instructions, if any. The Company's sole responsibility is to its Client and this document does not exonerate parties to a transaction from exercising all their rights and obligations under the transaction documents. This document cannot be reproduced except in full, without prior written approval of the Company. Any unauthorized alteration, forgery or falsification of the content or appearance of this document is unlawful and offenders may be prosecuted to the fullest extent of the law. Unless otherwise stated the results shown in this test report refer only to the sample(s) tested.

Attention: To check the authenticity of testing /inspection report & certificate, please contact us at telephone: (86-755) 8307 1443, or email: CN.Doccheck@sgs.com
 Room 101-901, Plant 4 & Room 101, Plant 2 & Room 101, Plant 3 & Room 301-501, Plant 3, Jianghao (Bantian) Industrial Plant Area, No. 430, Jihua Road, Bantian Community, Bantian Street, Longgang District, Shenzhen, Guangdong, China 518129 www.sgs.com.cn
 中国·广东·深圳市龙岗区坂田街道坂田社区吉华路430号江灏(坂田)工业厂区厂房4号101-901、2号101、3号101、3号301-501 邮编:518129 t:(86-755) 25328888 sgs.china@sgs.com

附件

元素检测流程图

样品按照下述流程被完全消解

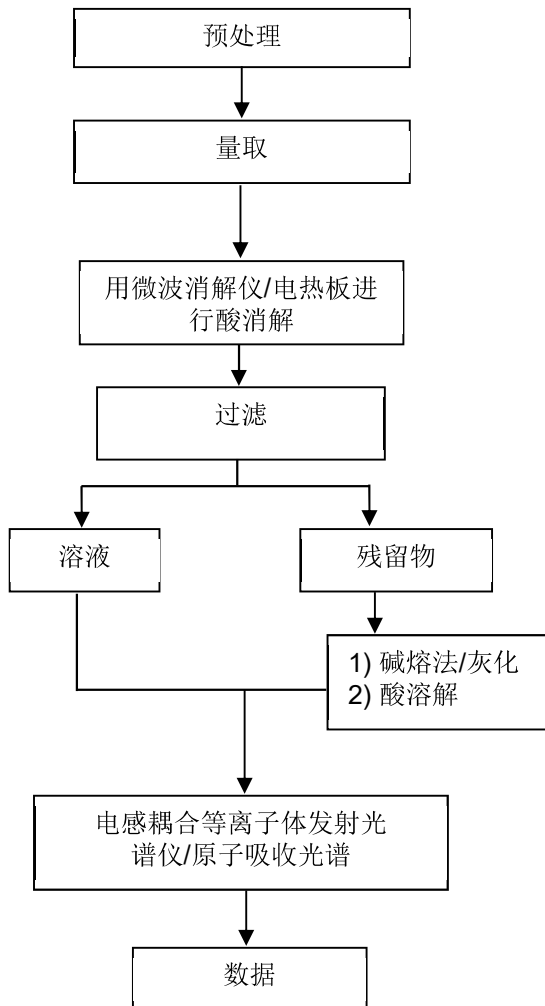

SGS-CSTC Standards Technical Services Co., Ltd.
Shenzhen Branch Testing Center Chemical Laboratory

Unless otherwise agreed in writing, this document is issued by the Company subject to its General Conditions of Service printed overleaf, available on request or accessible at <http://www.sgs.com/en/Terms-and-Conditions.aspx> and, for electronic format documents, subject to Terms and Conditions for Electronic Documents at <http://www.sgs.com/en/Terms-and-Conditions/Terms-e-Documents.aspx>. Attention is drawn to the limitation of liability, indemnification and jurisdiction issues defined therein. Any holder of this document is advised that information contained hereon reflects the Company's findings at the time of its intervention only and within the limits of Client's instructions, if any. The Company's sole responsibility is to its Client and this document does not exonerate parties to a transaction from exercising all their rights and obligations under the transaction documents. This document cannot be reproduced except in full, without prior written approval of the Company. Any unauthorized alteration, forgery or falsification of the content or appearance of this document is unlawful and offenders may be prosecuted to the fullest extent of the law. Unless otherwise stated the results shown in this test report refer only to the sample(s) tested.

Attention: To check the authenticity of testing /inspection report & certificate, please contact us at telephone: (86-755) 8307 1443, or email: CN.Doccheck@sgs.com

Room 101-901, Plant 4 & Room 101, Plant 2 & Room 101, Plant 3 & Room 301-501, Plant 3, Jianghao (Banian) Industrial Plant Area, No. 430, Jihua Road, Banian Community, Banian Street, Longgang District, Shenzhen, Guangdong, China 518129 www.sgs.com
中国·广东·深圳市龙岗区坂田街道坂田社区吉华路430号江灏(坂田)工业区厂房4号101-901、2号101、3号301-501 邮编:518129 t:(86-755) 25328888 sgs.china@sgs.com

六价铬检测流程图

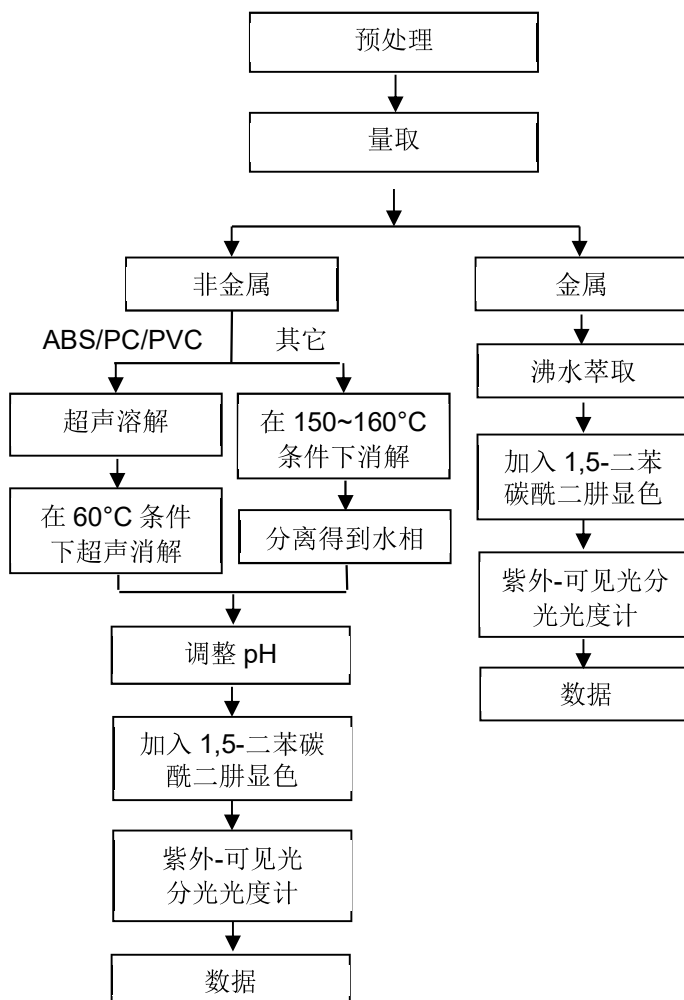

SGS-CSI Standards Technical Services Co., Ltd.
Shenzhen Branch Testing Center-Chemical Laboratory

Unless otherwise agreed in writing, this document is issued by the Company subject to its General Conditions of Service printed overleaf, available on request or accessible at <http://www.sgs.com/en/Terms-and-Conditions.aspx> and, for electronic format documents, subject to Terms and Conditions for Electronic Documents at <http://www.sgs.com/en/Terms-and-Conditions/Terms-e-Documents.aspx>. Attention is drawn to the limitation of liability, indemnification and jurisdiction issues defined therein. Any holder of this document is advised that information contained hereon reflects the Company's findings at the time of its intervention only and within the limits of Client's instructions, if any. The Company's sole responsibility is to its Client and this document does not exonerate parties to a transaction from exercising all their rights and obligations under the transaction documents. This document cannot be reproduced except in full, without prior written approval of the Company. Any unauthorized alteration, forgery or falsification of the content or appearance of this document is unlawful and offenders may be prosecuted to the fullest extent of the law. Unless otherwise stated the results shown in this test report refer only to the sample(s) tested.

Attention: To check the authenticity of testing /inspection report & certificate, please contact us at telephone: (86-755) 8307 1443, or email: CN.Doccheck@sgs.com

Room 101-901, Plant 4 & Room 101, Plant 2 & Room 101, Plant 3 & Room 301-501, Plant 3, Jianghao (Banlan) Industrial Plant Area, No. 430, Jihua Road, Banlan Community, Banlan Street, Longgang District, Shenzhen, Guangdong, China 518129 www.sgs.com.cn
中国·广东·深圳市龙岗区坂田街道坂田社区吉华路430号江灏(坂田)工业厂区厂房4号101-901、2号101、3号101、3号301-501 邮编:518129 t:(86-755) 25328888 sgs.china@sgs.com

PBB/PBDE/Phthalates 检测流程图

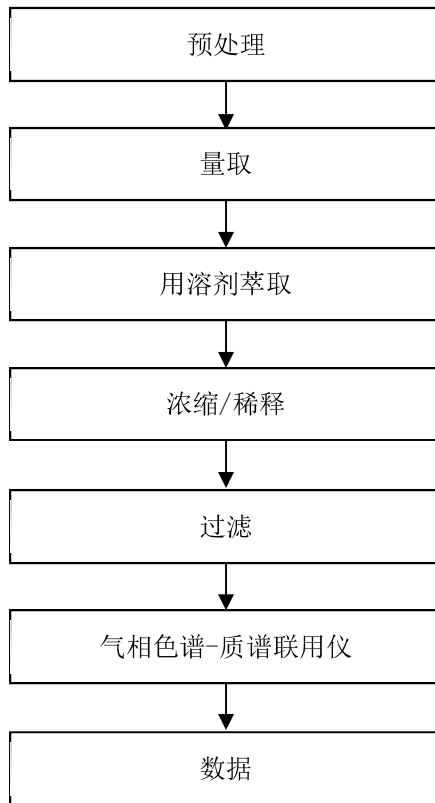

Unless otherwise agreed in writing, this document is issued by the Company subject to its General Conditions of Service printed overleaf, available on request or accessible at <http://www.sgs.com/en/Terms-and-Conditions.aspx> and, for electronic format documents, subject to Terms and Conditions for Electronic Documents at <http://www.sgs.com/en/Terms-and-Conditions/Terms-e-Documents.aspx>. Attention is drawn to the limitation of liability, indemnification and jurisdiction issues defined therein. Any holder of this document is advised that information contained hereon reflects the Company's findings at the time of its intervention only and within the limits of Client's instructions, if any. The Company's sole responsibility is to its Client and this document does not exonerate parties to a transaction from exercising all their rights and obligations under the transaction documents. This document cannot be reproduced except in full, without prior written approval of the Company. Any unauthorized alteration, forgery or falsification of the content or appearance of this document is unlawful and offenders may be prosecuted to the fullest extent of the law. Unless otherwise stated the results shown in this test report refer only to the sample(s) tested.

Attention: To check the authenticity of testing /inspection report & certificate, please contact us at telephone: (86-755) 8307 1443, or email: CN.Doccheck@sgs.com

SGS-CSTC Standards Technical Services Co., Ltd.
Shenzhen Branch Testing Center Chemical Laboratory

Room 101-901, Plant 4 & Room 101, Plant 2 & Room 101, Plant 3 & Room 301-501, Plant 3, Jianghao (Banlan) Industrial Plant Area, No. 430, Jihua Road, Banlan Community, Banlan Street, Longgang District, Shenzhen, Guangdong, China 518129 www.sgs.com
中国·广东·深圳市龙岗区坂田街道坂田社区吉华路430号江灏(坂田)工业区厂房4号101-901、2号101、3号101、3号301-501 邮编:518129 t:(86-755) 25328888 sgs.china@sgs.com

检测报告

编号: SZXEC24003572612

日期: 2024 年 11 月 20 日

第 7 页, 共 7 页

样品照片:

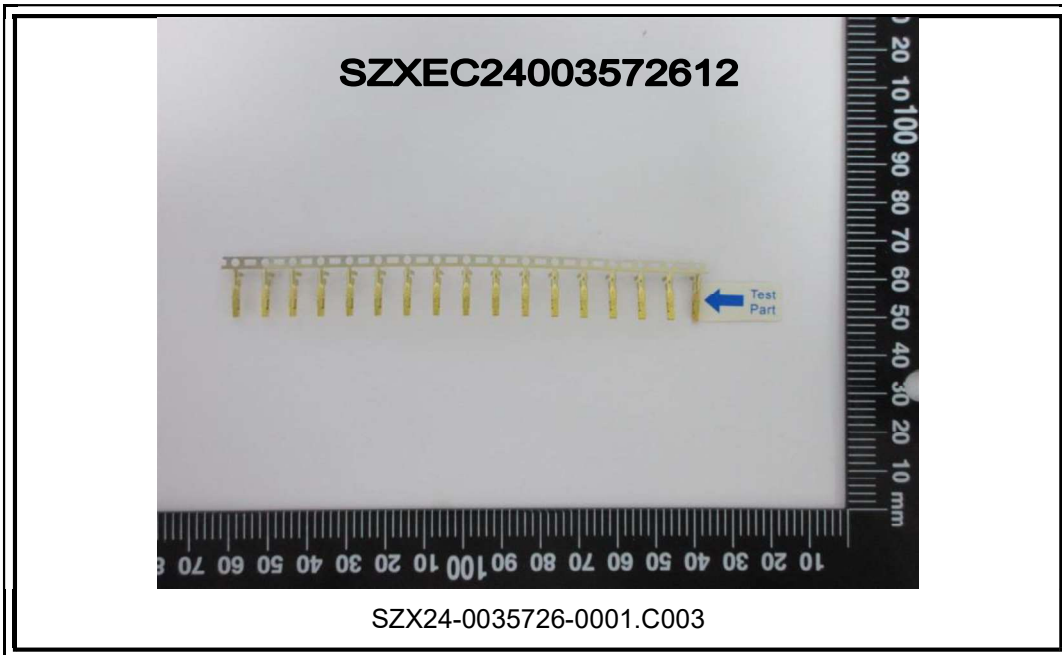

此照片仅限于随 SGS 正本报告使用

报告结束



Unless otherwise agreed in writing, this document is issued by the Company subject to its General Conditions of Service printed overleaf, available on request or accessible at <http://www.sgs.com/en/Terms-and-Conditions.aspx> and, for electronic format documents, subject to Terms and Conditions for Electronic Documents at <http://www.sgs.com/en/Terms-and-Conditions/Terms-e-Documents.aspx>. Attention is drawn to the limitation of liability, indemnification and jurisdiction issues defined therein. Any holder of this document is advised that information contained hereon reflects the Company's findings at the time of its intervention only and within the limits of Client's instructions, if any. The Company's sole responsibility is to its Client and this document does not exonerate parties to a transaction from exercising all their rights and obligations under the transaction documents. This document cannot be reproduced except in full, without prior written approval of the Company. Any unauthorized alteration, forgery or falsification of the content or appearance of this document is unlawful and offenders may be prosecuted to the fullest extent of the law. Unless otherwise stated the results shown in this test report refer only to the sample(s) tested.

Attention: To check the authenticity of testing /inspection report & certificate, please contact us at telephone: (86-755) 8307 1443, or email: CN.Doccheck@sgs.com

SGS-CSTC Standards Technical Services Co., Ltd.
Shenzhen Branch Testing Center-Chemical Laboratory

Room 101-901, Plant 4 & Room 101, Plant 2 & Room 101, Plant 3 & Room 301-501, Plant 3, Jianghao (Bantian) Industrial Plant Area, No. 430, Jihua Road, Bantian Community, Bantian Street, Longgang District, Shenzhen, Guangdong, China 518129 www.sgs.com
中国·广东·深圳市龙岗区坂田街道坂田社区吉华路430号江灏(坂田)工业区厂房4号101-901、2号101、3号301-501 邮编:518129 t:(86-755) 25328888 sgs.china@sgs.com