



Guangdong Taixing photoelectric technology Co., LTD

规格书 Product specification

客户名称:

Customer _____

客户商品代码:

Customer Type _____

品名:

Product _____

产品型号: TX-TBGYBMRHQHH-06

RART _____

审核:

CHeck _____

制作:

Design _____

日期:

2024.05.15

Date _____

WEB : www.taixingled.com

E-MAIL : gd@taixingled.com

TEL : 0769-21683819

Characteristics 特点 :

1.6mm 0.8mm SMTLED, 0.65mm thickness.

长1.6毫米 宽0.8毫米, 厚0.65毫米.

Luminous color and colloid: Green/colloid transparent.

发光颜色和胶体: 绿色/胶体透明.

Package: 4000pcs/reel

包装: 4000个/卷

Features 产品特征 :

Small size, small heat, high light efficiency, low light decay.

体积小, 发热量小, 光效高, 光衰小.

Fast reaction speed, long life, a variety of colors to choose.

反应速度快, 寿命长, 有多种颜色可供选择.

Suitable for SMT assembly and welding processes.

适用于SMT组装和焊接工艺.

Environmental protection process meets ROHS environmental requirements.

环保工艺符合ROHS环保要求.

Package Dimension 外观尺寸:

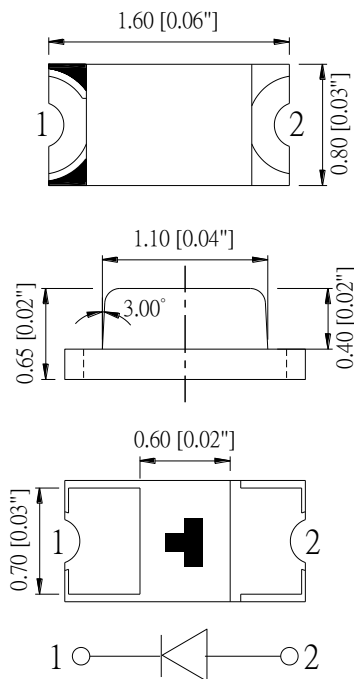

Recommend Soldering Pad 推荐焊盘

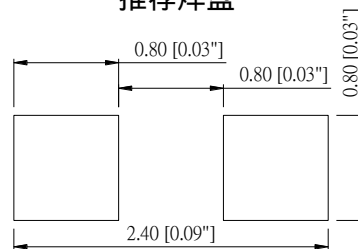

Notes 备注 :

- All dimensions are in millimeters (inches); 所有尺寸均以毫米(英寸)为单位;
- Tolerances are 0.1mm 0.004inch unless otherwise noted. 除非另有说明, 公差0.1mm0.004英寸.

Absolute maximum ratings (TA=25°C) 绝对最大额定值(TA=25)

Parameter 参数	Symbol 符号	Value 数值	Unit 单位
Forward current 正向电流 www.taixingled.com	If	30	mA
Reverse voltage 反向电压	Vr	5	V
Power dissipation 功耗	Pd	108	mW
Operating temperature 工作温度	Top	-40 ~+85	°C
ESD(Human-body mode 静电	--	2	KV
Storage temperature 储存温度	Tstg	-40 ~+85	°C
Peak pulsing current (1/8 duty f=1kHz) 峰值脉冲电流	Ifp	125	mA

Electro-optical characteristics (TA=25°C) 光电特性(TA = 25) www.taixingled.com

Parameter 参数	Test Condition 测试条件	Symbol 符号	Value 数值			Unit 单位
			Min 最小	Typ 中间	Max 最大	
Wavelength at peak emission 峰值发射波长	If=20mA	λ_p	--	525	--	nm
Spectral half bandwidth 半波宽	If=20mA	$\Delta\lambda$	--	13	--	nm
Dominant wavelength 主波长	If=20mA	λ_d	515	--	530	nm
Forward voltage 正向电压	If=20mA	Vf	2.8	--	3.4	V
Luminous intensity 光强度	If=20mA	Iv	500	--	900	mcd
Viewing angle at 50% Iv 50%视距下的视角	If=10mA	2 $\theta_{1/2}$	--	120	--	Deg
Reverse current 反向漏电流	Vr=5V	Ir	--	--	10	μ A

www.taixingled.com

Typical Optical Characteristics Curves 典型光学特性曲线

www.taixingled.com

Forward Current vs Forward Voltage
Ta=25°C 正向电流VS电压

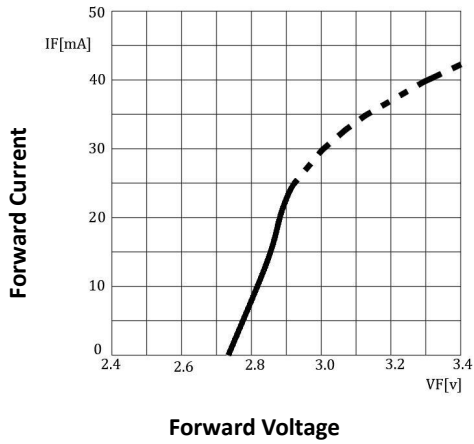

Forward Current Derating Curve
正向电流降额曲线

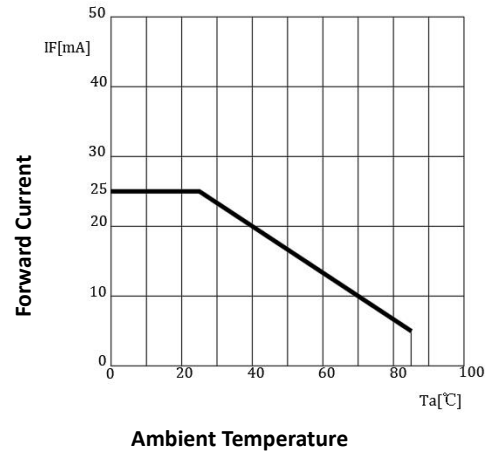

Radiation Characteristics 辐射特性
IF=10mA Ta=25°C

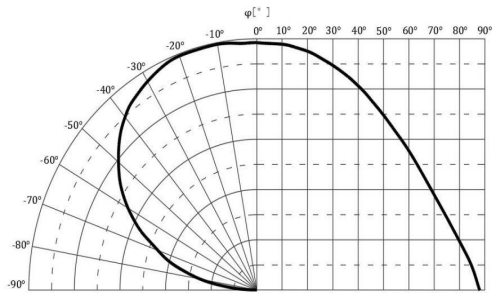

Relative Spectral Emission 相对光谱发射
IF=20mA, Ta=25°C

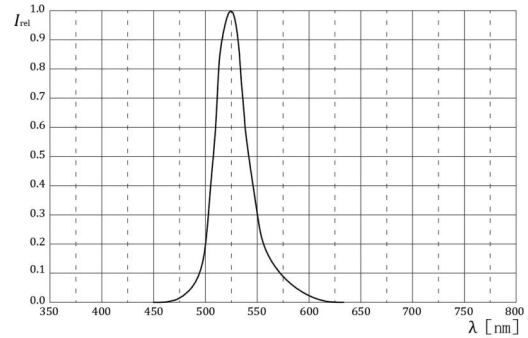

www.taixingled.com

Reflow Profile 炉温

■ Reflow Temp/Time 回流焊温度/时间 www.taixingled.com

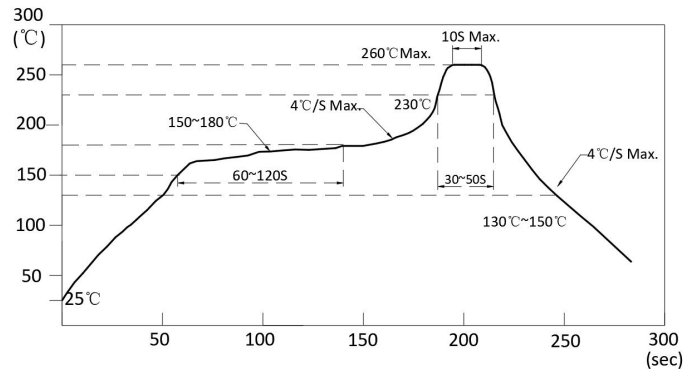

Notes: 备注：

1. We recommend the reflow temperature 245°C (±5°C). The maximum soldering temperature should be limited to 260°C www.taixingled.com
我们推荐回流温度为245 (±5)。最高焊接温度应限制在260。
2. Don't cause stress to the epoxy resin while it is exposed to high temperature.
环氧树脂暴露在高温下时不要对其造成应力。
3. Number of reflow process shall be 2 times or less.
回流焊次数不超过2次。

■ Soldering iron 烙铁使用

Basic spec is ≤ 5sec when 320°C (±20°C). If temperature is higher, time should be shorter (+10°C → -1sec). Power dissipation of iron should be smaller than 20W, and temperatures should be controllable. Surface temperature of the device should be under 350°C

基本规格为320 (±20)时5秒。温度越高，时间越短(+10 -1秒)。烙铁的功耗应小于20W，温度应可控设备温度应在350 以下。

■ Rework 返工

1. Customer must finish rework within 5 sec under 340°C. 客户必须在340 下5秒内完成返工。
2. The head of iron cannot touch copper foil. 铁头不能碰到铜箔。
3. Twin-head type is preferred. 首选双头型。 www.taixingled.com

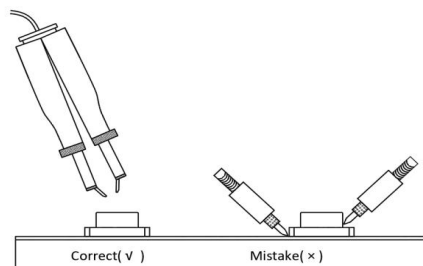

- Avoid rubbing or scraping the resin by any object, during high temperature, for example reflow solder etc.
避免任何物体摩擦或刮擦树脂，在高温下，如回流焊等。

Handling precautions 使用处理措施 www.taixingled.com

1. Drive Method. 驱动方法

A LED is a current-operated device. In order to ensure intensity uniformity on multiple LEDs connected in parallel in an application, it is recommended that a current limiting resistor be incorporated in the drive circuit, in series with each LED as shown in Circuit below. LED是电流操作的器件。为了确保应用中并联的多个LED的强度均匀性，建议在驱动电路中加入一个限流电阻，与每个LED串联，如下图所示：

www.taixingled.com

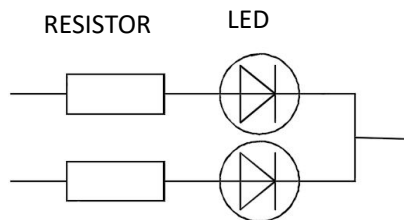

2. Storage 储存

2.1 Do not open moisture proof bag before the products are ready to use.

在产品准备使用之前，请勿打开防潮袋。

2.2 Before opening the package: The LEDs should be kept at 30°C or less and 60% RH or less.

打开包装前：led应保持在30 以下，60%RH以下。

2.3 After the package is opened, the products should be used within a week or they should be keeping to store at ≤ 20 R.H. with zip-lock sealed.

打开包装后，产品应在一周内用完或以 20R.H. 的温度保存，并以拉链密封。

3. Baking 烘烤处理

It is recommended to baking before soldering when the pack is unsealed after 72hrs. The Conditions are as followings: 当包装在72小时后打开密封时，建议在焊接前进行烘烤。条件如下：

3.1 $60 \pm 3^\circ\text{C}$ x (12~24hrs) and $< 5\%$ RH, taped reel type

3.2 $100 \pm 3^\circ\text{C}$ x (45min~1hr), bulk type

3.3 $130 \pm 3^\circ\text{C}$ x (15~30min), bulk type

Test items and results of reliability 可靠性测试专案及结果

Test Item 测试项目	Test Conditions 测试条件	Standard Test Method 标准试验方法	Note 注意	Number of Test 测试次数
Reflow Soldering 静态回流焊	Ta=260±5℃,Time=10±2S	JB/T 10845-2008	3times	0/22
Temperature Cycling 静态温度迴圈	-40±5℃ 30±1min ↑→(25℃/5±1min)↓ 100±5℃ 30±1min	GB/T 2423.22-2012	100cycles	0/22
High Humidity High Temp. Storage Life 静态高温高湿	Ta=85±5℃,ψ(%)=85±5%RH	GB/T 2423.3-2006	1000hrs	0/22
High Temperature Storage Life 静态高温储存	Ta=100±5℃,non-operating	GB/T 2423.2-2008	1000hrs	0/22
Low Temperature Storage Life 静态低温储存	Ta=-40±5℃,non-operating	GB/T 2423.1-2008	1000hrs	0/22
Life Test 动态室温通电	Ta=26±5℃,@20mA, ψ(%)=25%RH~55%RH	--	1000hrs	0/22
Low Temperature Operating Life 动态低温通电	a=-20±5℃,@20mA	GB/T 2423.1-2008	1000hrs	0/22

Notes 备注：

1. The tolerance of luminous intensity (Iv) is ±15% . 发光强度(Iv)公差为±15%。
2. The tolerance of dominant wavelength is ±2nm. 主导波长公差为±2nm。
3. The tolerance of Voltage is ±0.1V. 电压公差为±0.1V www.taixingled.com
4. This specification is a standard specification of our factory, can make in accordance with customer's special requirement. 本规格为我厂标准规格，可根据客户的特殊要求定做。

Series SMD Chip LED Lamps Packaging Specifications 系列贴片led灯封装规范

● Feeding Direction 编带方向

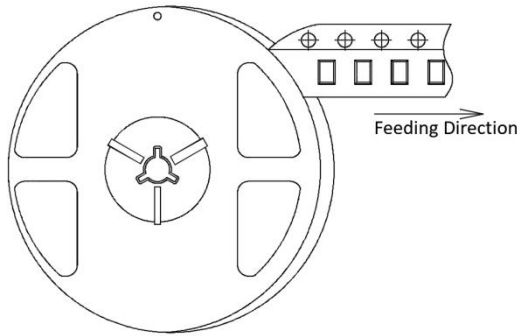

● Dimensions of Reel (Unit: mm) 卷盘尺寸

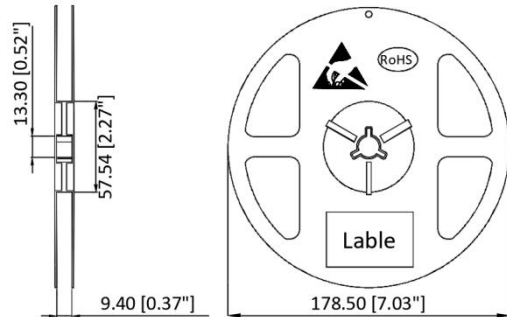

● Dimensions of Tape (Unit: mm) 胶带尺寸 (单位:mm)

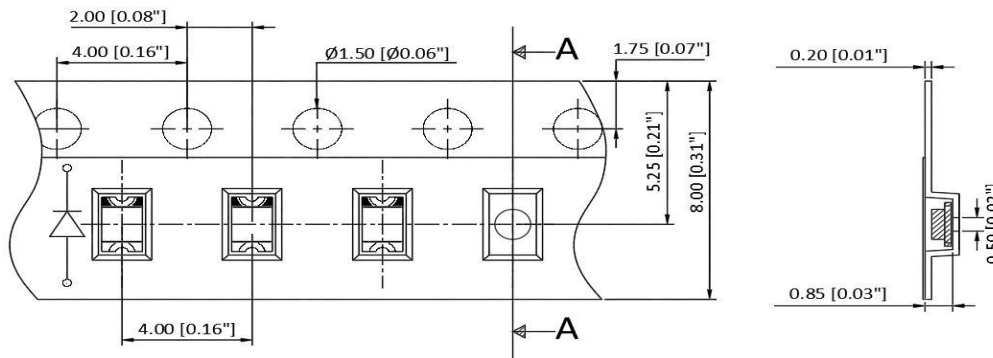

● Arrangement of Tape 编带方式

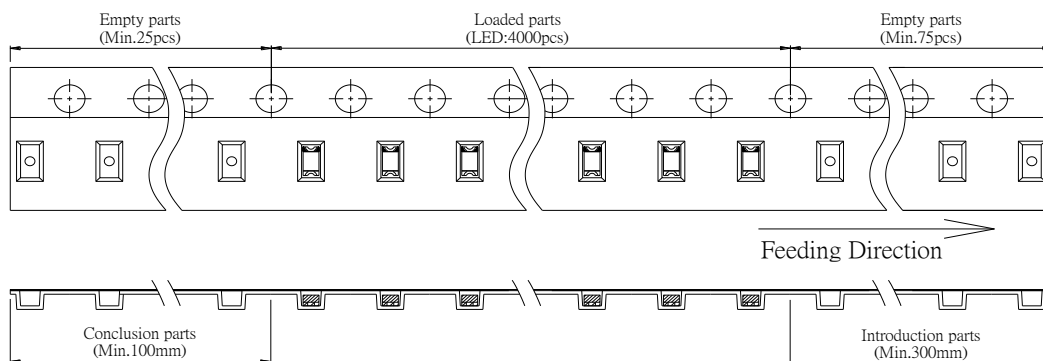

Notes 备注 :

1. Empty component pockets are sealed with top cover tape;B 用顶盖胶带密封空部件口袋;
2. The maximum number of missing lamps is two; 最多漏灯为2个
3. 4,000pcs/Reel. 4000个每盘

Series Chip LED Lamps Packaging Specifications 系列贴片led灯封装规范

- **Transportation Packing 运输包装**
www.taixingled.com

