



Guangdong Taixing photoelectric technology Co., LTD

## 规格书 Product specification

客户名称:

Customer

客户商品代码:

Customer Type

品名:

Product

产品型号: TX-TBGYBMRHQZS-06

RART

审核:

CHeck

制作:

Design

日期:

2024.07.10

Date

WEB : [www.taixingled.com](http://www.taixingled.com)

E-MAIL : [gd@taixingled.com](mailto:gd@taixingled.com)

TEL : 0769-21683819

**Characteristics 特点：**

1.6mm 0.8mm SMTLED, 0.65mm thickness.  
 长1.6毫米 宽0.8毫米, 厚0.65毫米.  
 Luminous color and colloid: Green/colloid transparent.  
 发光颜色和胶体: 绿色/胶体透明.  
 Package: 4000pcs/reel  
 包装: 4000个/卷

**Features 产品特征：**

Small size, small heat, high light efficiency, low light decay.  
 体积小, 发热量小, 光效高, 光衰小.  
 Fast reaction speed, long life, a variety of colors to choose.  
 反应速度快, 寿命长, 有多种颜色可供选择.  
 Suitable for SMT assembly and welding processes.  
 适用于SMT组装和焊接工艺.  
 Environmental protection process meets ROHS environmental requirements.  
 环保工艺符合ROHS环保要求.

**Package Dimension 外观尺寸：**

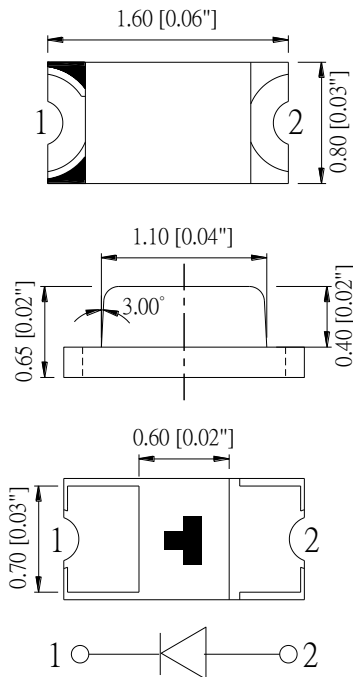

**Recommend Soldering Pad 推荐焊盘**

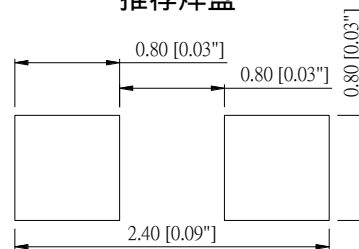

Tips: This product is only suitable for indoor, consumer category indicator light, if there are other uses, please consult our business recommendation.

温馨提示：此款产品仅适用于室内，消费品类指示灯，如有其他用途需要具体请咨询我们业务推荐。

**Notes 备注：**

- All dimensions are in millimeters (inches); 所有尺寸均以毫米(英寸)为单位；
- Tolerances are 0.1mm 0.004inch unless otherwise noted. 除非另有说明，公差0.1mm0.004英寸。

Absolute maximum ratings (TA=25°C) 绝对最大额定值(TA=25 )

Parameter 参数	Symbol 符号	Value 数值	Unit 单位
Forward current 正向电流 <a href="http://www.taixingled.com">www.taixingled.com</a>	If	10	mA
Reverse voltage 反向电压	Vr	5	V
Power dissipation 功耗	Pd	15	mW
Operating temperature 工作温度	Top	-40 ~+85	°C
ESD(Human-body mode 静电)	--	2	KV
Storage temperature 储存温度	Tstg	-40 ~+85	°C
Peak pulsing current (1/8 duty f=1kHz) 峰值脉冲电流	Ifp	20	mA

Electro-optical characteristics (TA=25°C) 光电特性(TA = 25 ) [www.taixingled.com](http://www.taixingled.com)

Parameter 参数	Test Condition 测试条件	Symbol 符号	Value 数值			Unit 单位
			Min 最小	Typ 中间	Max 最大	
Wavelength at peak emission 峰值发射波长	If=5mA	$\lambda_p$	--	525	--	nm
Spectral half bandwidth 半波宽	If=5mA	$\Delta\lambda$	--	13	--	nm
Dominant wavelength 主波长	If=5mA	$\lambda_d$	515	--	530	nm
Forward voltage 正向电压	If=5mA	Vf	2.6	--	3.2	V
Luminous intensity 光强度	If=5mA	Iv	150	--	300	mcd
Viewing angle at 50% Iv 50%视距下的视角	If=10mA	2 $\theta$ 1/2	--	120	--	Deg
Reverse current 反向漏电流	Vr=5V	Ir	--	--	10	$\mu$ A

[www.taixingled.com](http://www.taixingled.com)

## Typical Optical Characteristics Curves 典型光学特性曲线

[www.taixingled.com](http://www.taixingled.com)

**Forward Current vs Forward Voltage**  
Ta=25°C 正向电流VS电压

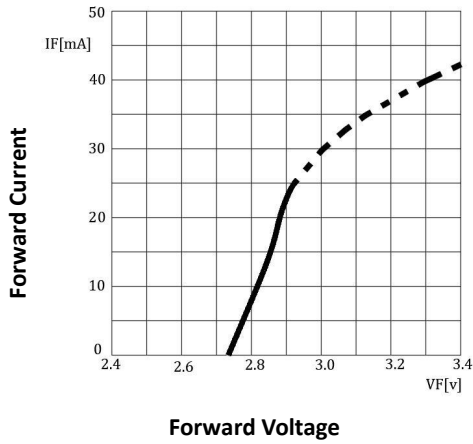

**Forward Current Derating Curve**  
正向电流降额曲线

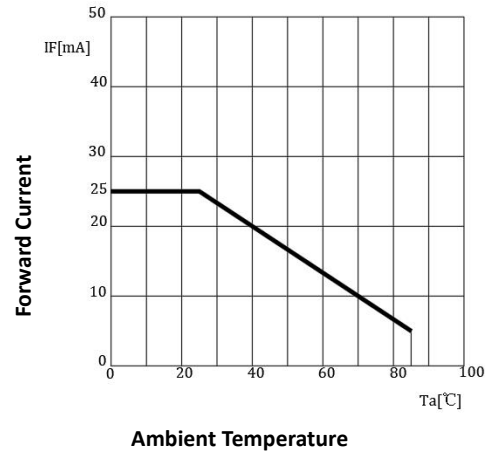

**Radiation Characteristics 辐射特性**  
IF=10mA Ta=25°C

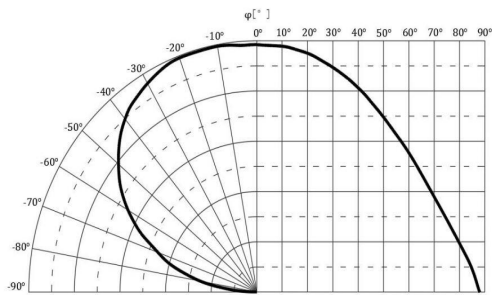

**Relative Spectral Emission 相对光谱发射**  
IF=5mA, Ta=25°C

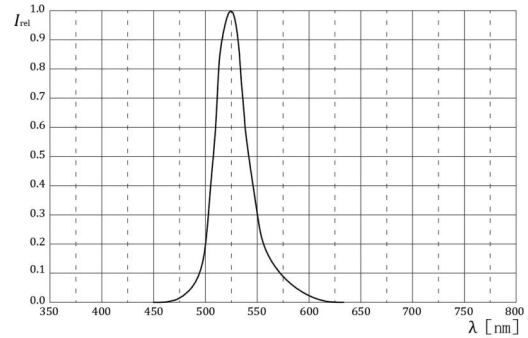

[www.taixingled.com](http://www.taixingled.com)

**Reflow Profile 炉温**

■ Reflow Temp/Time 回流焊温度/时间 [www.taixingled.com](http://www.taixingled.com)

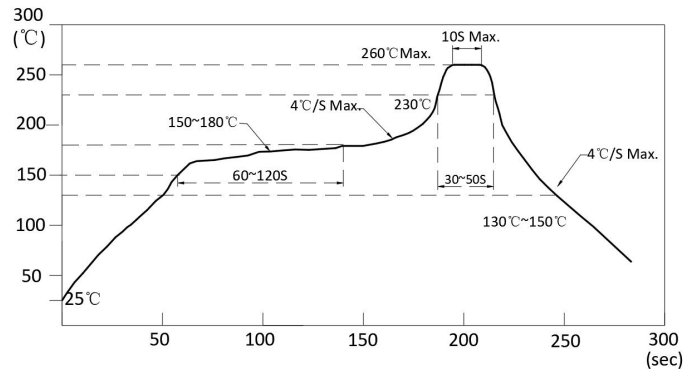

Notes: 备注：

1. We recommend the reflow temperature 245°C (±5°C). The maximum soldering temperature should be limited to 260°C [www.taixingled.com](http://www.taixingled.com)  
我们推荐回流温度为245 (±5)。最高焊接温度应限制在260。
2. Don't cause stress to the epoxy resin while it is exposed to high temperature.  
环氧树脂暴露在高温下时不要对其造成应力。
3. Number of reflow process shall be 2 times or less.  
回流焊次数不超过2次。

■ Soldering iron 烙铁使用

Basic spec is ≤ 5sec when 320°C (±20°C). If temperature is higher, time should be shorter (+10°C → -1sec). Power dissipation of iron should be smaller than 20W, and temperatures should be controllable. Surface temperature of the device should be under 350°C

基本规格为320 (±20)时5秒。温度越高，时间越短(+10 -1秒)。烙铁的功耗应小于20W，温度应可控设备温度应在350 以下。

■ Rework 返工

1. Customer must finish rework within 5 sec under 340°C. 客户必须在340 下5秒内完成返工。
2. The head of iron cannot touch copper foil. 铁头不能碰到铜箔。
3. Twin-head type is preferred. 首选双头型。 [www.taixingled.com](http://www.taixingled.com)

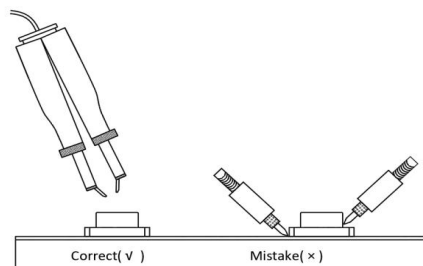

- Avoid rubbing or scraping the resin by any object, during high temperature, for example reflow solder etc.  
避免任何物体摩擦或刮擦树脂，在高温下，如回流焊等。

Handling precautions 使用处理措施 [www.taixingled.com](http://www.taixingled.com)

### 1. Drive Method. 驱动方法

A LED is a current-operated device. In order to ensure intensity uniformity on multiple LEDs connected in parallel in an application, it is recommended that a current limiting resistor be incorporated in the drive circuit, in series with each LED as shown in Circuit below. LED是电流操作的器件。为了确保应用中并联的多个LED的强度均匀性，建议在驱动电路中加入一个限流电阻，与每个LED串联，如下图所示：

[www.taixingled.com](http://www.taixingled.com)

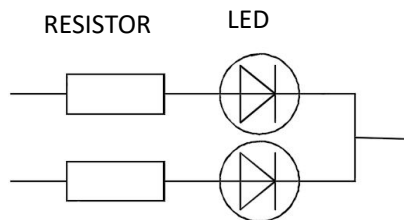

### 2. Storage 储存

2.1 Do not open moisture proof bag before the products are ready to use.

在产品准备使用之前，请勿打开防潮袋。

2.2 Before opening the package: The LEDs should be kept at 30°C or less and 60% RH or less.

打开包装前：LED应保持在30°C以下，60%RH以下。

2.3 After the package is opened, the products should be used within a week or they should be keeping to store at  $\leq 20$  R.H. with zip-lock sealed.

打开包装后，产品应在一周内用完或以  $\leq 20$  R.H. 的温度保存，并以拉链密封。

### 3. Baking 烘烤处理

It is recommended to baking before soldering when the pack is unsealed after 72hrs. The Conditions are as followings: 当包装在72小时后打开密封时，建议在焊接前进行烘烤。条件如下：

3.1  $60 \pm 3^\circ\text{C}$  x (12~24hrs) and  $< 5\%$  RH, taped reel type

3.2  $100 \pm 3^\circ\text{C}$  x (45min~1hr), bulk type

3.3  $130 \pm 3^\circ\text{C}$  x (15~30min), bulk type

**Test items and results of reliability 可靠性测试专案及结果**

Test Item 测试项目	Test Conditions 测试条件	Standard Test Method 标准试验方法	Note 注意	Number of Test 测试次数
Reflow Soldering 静态回流焊	Ta=260±5℃,Time=10±2S	JB/T 10845-2008	3times	0/22
Temperature Cycling 静态温度迴圈	-40±5℃ 30±1min ↑→(25℃/5±1min)↓ 100±5℃ 30±1min	GB/T 2423.22-2012	100cycles	0/22
High Humidity High Temp. Storage Life 静态高温高湿	Ta=85±5℃,ψ(%)=85±5%RH	GB/T 2423.3-2006	1000hrs	0/22
High Temperature Storage Life 静态高温储存	Ta=100±5℃,non-operating	GB/T 2423.2-2008	1000hrs	0/22
Low Temperature Storage Life 静态低温储存	Ta=-40±5℃,non-operating	GB/T 2423.1-2008	1000hrs	0/22
Life Test 动态室温通电	Ta=26±5℃,@5mA, ψ(%)=25%RH~55%RH	--	1000hrs	0/22
Low Temperature Operating Life 动态低温通电	a=-20±5℃,@5mA	GB/T 2423.1-2008	1000hrs	0/22

**Notes 备注：**

1. The tolerance of luminous intensity (Iv) is ±15% . 发光强度(Iv)公差为±15%。
2. The tolerance of dominant wavelength is ±2nm. 主导波长公差为±2nm。
3. The tolerance of Voltage is ±0.1V. 电压公差为±0.1V [www.taixingled.com](http://www.taixingled.com)
4. This specification is a standard specification of our factory, can make in accordance with customer's special requirement. 本规格为我厂标准规格，可根据客户的特殊要求定做。

Series SMD Chip LED Lamps Packaging Specifications 系列贴片led灯封装规范

● Feeding Direction 编带方向

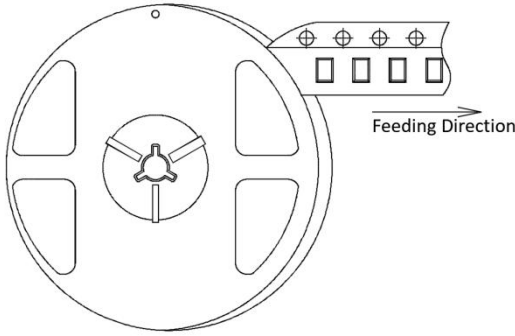

● Dimensions of Reel (Unit: mm) 卷盘尺寸

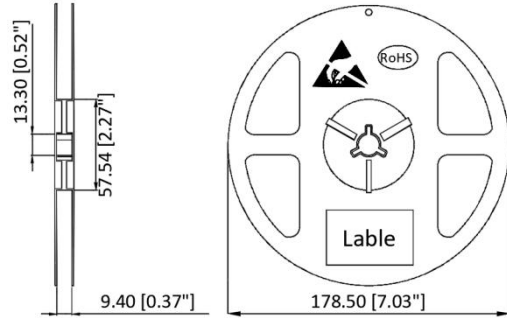

● Dimensions of Tape (Unit: mm) 胶带尺寸 (单位:mm)

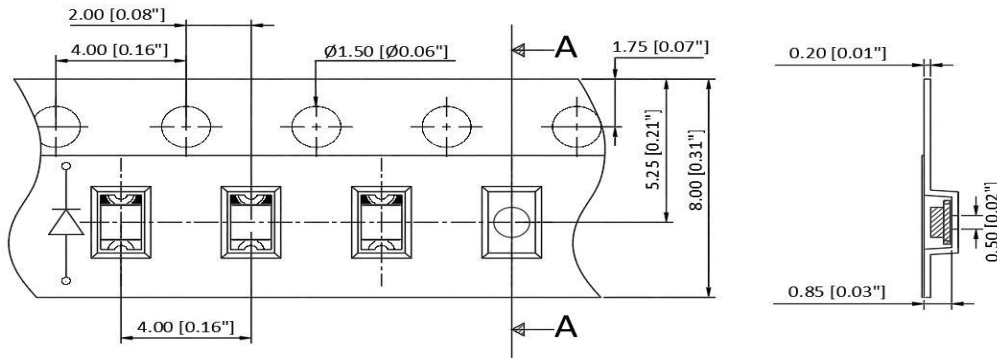

● Arrangement of Tape 编带方式

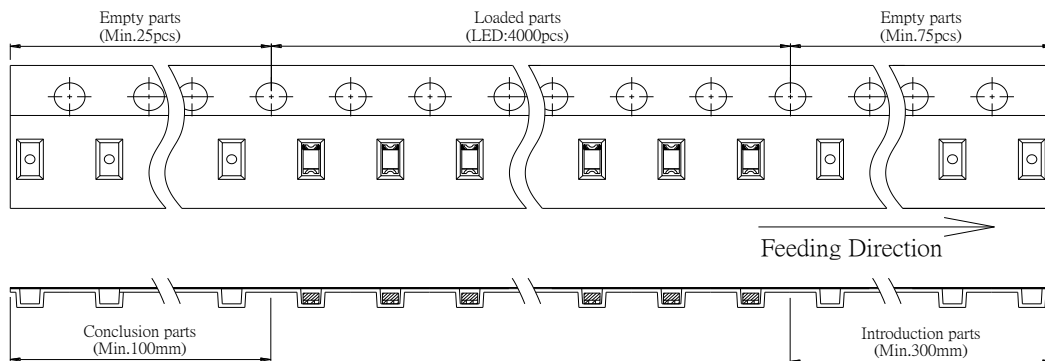

Notes 备注 :

1. Empty component pockets are sealed with top cover tape;B 用顶盖胶带密封空部件口袋;
2. The maximum number of missing lamps is two; 最多漏灯为2个
3. 4,000pcs/Reel. 4000个每盘

Series Chip LED Lamps Packaging Specifications 系列贴片led灯封装规范

- **Transportation Packing 运输包装**  
[www.taixingled.com](http://www.taixingled.com)

